

*movinglife*<sup>®</sup>

# OWNER'S MANUAL

**ATTO**



**ATTO SPORT**  
**ATTO SPORT MAX**

[www.movinglife.com](http://www.movinglife.com)

GET TO KNOW



**ATTO**  
**ATTO SPORT**  
**ATTO SPORT MAX**





# WELCOME!

The Movinglife Team welcomes you to the global family of ATTO users!

Movinglife's mission is to produce top-quality products and to continually deliver supportive services that benefit mobility-limited users. Made by professionals based on real users' experiences, ATTO products are delivered knowing that these solutions will become an extension of you and an integral part of your life. As such, we have designed and manufactured ATTO's many components with great attention and care, which we know you will appreciate. However, we urge you to contact us with any comment, suggestion, complaint, or compliment. We want to hear it all! So, please register your ATTO and share your feedback with us via the dedicated form on our website.

Enjoy your ATTO!

- **Please note that this manual refers to the ATTO Line of products, which includes ATTO, ATTO SPORT, ATTO SPORT MAX and other ATTO solutions in operation. When referring to features that do not appear in all products, this will be clearly stated in the manual texts.**
- Please refrain from using an ATTO Mobility Scooter until you have read and understood this manual.

## REGISTER NOW

Please visit Movinglife and register your ATTO. Once registered, you will become part of the Movinglife community, you will receive safety notices and information, and will be first to enjoy news, updates, and special benefits.

[www.movinglife.com/register](http://www.movinglife.com/register)

# TABLE OF CONTENTS

PREFACE .....	12
ABOUT THIS MANUAL .....	14
Owner's Manual Purpose .....	14
Warnings and Cautions.....	15
Users and Certified Technicians .....	16
BACKGROUND.....	17
Certification and Compliance .....	18
SAFETY .....	19
Safety and Usage Instructions .....	20
First Time Users .....	20
General .....	21
Driving in Public.....	21
Sharp Turns.....	22
Driving Angles .....	22
Reversing .....	23
Arms and Legs .....	23
Weather.....	24
Power Off .....	24

Freewheel .....	24
Lifting.....	25
Load .....	25
Medical Conditions .....	25
External Devices .....	26
Unusual Usage.....	26
Battery and Charger .....	26
Modifications .....	27
Weight Limitation .....	27
Temperature .....	28
Safety Labels .....	29
Damaged Labels.....	30
Compliance and Warning Labels .....	31
EMC Information .....	31
Electromagnetic Interference (EMI) from Radio Wave Sources.....	31
Mobility Scooter Electromagnetic Interference (EMI).....	33
Important .....	34
Radiation .....	34
ATTONOMY .....	35
Features available for both ATTO and ATTO SPORT .....	35
Features available for both ATTO SPORT and ATTO SPORT MAX only.....	38

---

Opening .....	40
Installing the Battery .....	44
Removing the Battery .....	44
Adjusting for Maximum Comfort .....	46
Adjusting Driving Console Height .....	46
Adjusting Driving Console Angle.....	47
Tiller Angle Adjustment.....	49
Driving Console.....	50
ON/OFF and Speed Control Buttons .....	50
Display Panel .....	51
Menus (ATTO SPORT).....	51
Throttle .....	52
USB Port .....	53
Display Dimming .....	53
Beep Sounds.....	53
Handlebar Grips .....	53
Adjusting the Handlebar Grips (ATTO SPORT) .....	54
Getting On ATTO .....	55
ATTO Sport Front Handle Brake .....	55
Getting Off ATTO .....	55

Driving .....	56
Turning ATTO On.....	56
Ignition Using the Remote Key Fob (ATTO SPORT) .....	57
Forward Driving .....	57
Reverse Driving.....	58
Cruise Control (ATTO SPORT Only) .....	58
Emergency Braking .....	59
Steering.....	59
Steering in a Tight Spot .....	59
Steering in Reverse .....	59
Turning Corners .....	62
Folding (Closing).....	62
Trolley Mode .....	66
Separating the Chassis .....	67
Lifting Separated Chassis .....	69
Connecting the Chassis .....	70
Operating the Freewheel .....	72
Battery and Charger.....	73
XL Flight Battery (ATTO SPORT) .....	73
Charging the Battery.....	74
Maximizing Battery Lifetime .....	74



---

Remote Key Fob (ATTO SPORT).....	74
Rear Light Lifting Handle (ATTO SPORT) .....	76
Charging the Rear Light Lifting Handle .....	76
Error Codes .....	77
TRANSPORTING ATTO.....	78
TROUBLESHOOTING.....	79
If Your ATTO Does Not Operate .....	79
ATTO Is ON But Does Not Move.....	79
Charging Problems .....	79
MAINTENANCE .....	80
Electrical Fuse .....	80
Possible Causes of a Blown Fuse .....	80
Replacing a Blown Fuse .....	80
Wheels and Tires .....	82
Lubrication .....	82
Battery .....	83
Battery and Charging .....	83
Cleaning and Body Care .....	83
Maintaining the Front Handle Brake (ATTO SPORT) .....	84
Storage .....	84

Disposal .....	85
Spare Parts .....	85
Accessories .....	85
SPECIFICATIONS.....	86
Model – ATTO Mobility Scooter .....	86
Speed.....	86
Weight .....	86
Weight Capacity .....	86
Dimensions.....	86
Ground Clearance .....	86
Front Wheel Drive Motor.....	86
Tires .....	87
Battery.....	87
Charger .....	87
Controller.....	87
Turning Radius .....	87
Freewheel Mode.....	87
Maximum Incline .....	87
Height Restrictions .....	87
Environment .....	87
Flammability .....	88

---

Manufacturer Responsibility .....	88
Model – ATTO SPORT Mobility Scooter .....	89
Speed.....	89
Weight.....	89
Weight Capacity .....	89
Dimensions.....	89
Ground Clearance .....	89
Front Wheel Drive Motor.....	89
Tires .....	89
Battery.....	89
Operating Range.....	90
Charger .....	90
Controller.....	90
Turning Radius .....	90
Freewheel Mode.....	90
Maximum Incline .....	90
Height Restrictions .....	90
Environment .....	90
Flammability .....	91
Manufacturer Responsibility .....	91

Model – ATTO SPORT MAX Mobility Scooter.....	92
Speed.....	92
Weight.....	92
Weight Capacity .....	92
Dimensions.....	92
Ground Clearance .....	92
Front Wheel Drive Motor.....	92
Tires .....	93
Battery.....	93
Operating Range .....	93
Charger .....	93
Controller.....	93
Turning Radius .....	93
Freewheel Mode.....	93
Maximum Incline .....	93
Height Restrictions .....	93
Environment .....	94
Flammability .....	94
Manufacturer Responsibility .....	94
CONTACT INFORMATION .....	95
NOTES.....	96

# PREFACE

## Important Notice

This document is delivered subject to the following conditions and restrictions:

This Owner's Manual contains proprietary information of Movinglife Ltd. This information is supplied solely for the purpose of assisting authorized users of Movinglife Ltd. products.

This manual is designed to serve as an accompanying document for the ATTO Mobility Scooters, which includes the ATTO, the ATTO SPORT, and the ATTO SPORT MAX.

- Any reference to the ATTO refers to both the ATTO and the ATTO SPORT.
- Any reference to the ATTO SPORT is relevant also to the ATTO SPORT MAX.

When referring to a specific make, it will be stated by name.

No part of the contents of this manual may be used for any other purpose, disclosed to any

person or firm, or reproduced by any means, without the express prior written permission of Movinglife Ltd.

The text and drawings in this manual are for the purposes of illustration and reference only. The specifications on which they are based are subject to change without notice.

## Trademarks

ATTO and ATTO SPORT are registered trademarks of Movinglife Ltd.

Other company, brand, product, and service names are for identification purposes only and may be trademarks or registered trademarks of their respective holders. Data is subject to change without notice.

This product is covered by Movinglife Ltd. patents.

### **▲ CAUTION**

Federal law restricts this device to sale by or on the order of a physician.

## Indications for Use

Movinglife ATTO Mobility Scooters compose a line of mostly indoor mobility scooters that provides transportation for people with limited mobility or anyone that requires a mobility scooter.

## Designated Users

This motorized, three-wheeled vehicle is a battery-powered device intended for medical purposes. It is used for both inside and outside transportation.

The ATTO is intended for people with temporary or permanent walking difficulties or walking disability, due to an injury, a physical disability, age, or a medical condition.

Designated users should conduct a preliminary assessment of eyesight, reaction time, balance and posture, ability to sit for long periods of time, concentration, and ability to get on and off the mobility scooter. They should be able to judge

distances, recognize obstacles, and hazards, and be able to see pedestrians and other road users. The designated ATTO is the occupant who will be driving it and who may be aided by an assistant for non-driving operations such as opening and folding the mobility scooter.

# ABOUT THIS MANUAL

## NOTE

For information on opening and unboxing ATTO and ATTO SPORT, please refer to the UNBOXING SUPPLEMENT located in the product's packaging.

with all the answers to questions that may arise during the operation and use of the ATTO.

If you encounter a question for which you have not found an answer, please contact a Movinglife dealer close to you, or the company's Technical Support, via our website: [www.movinglife.com](http://www.movinglife.com)

## Owner's Manual Purpose

This Owner's Manual is an essential resource for any user of a Movinglife ATTO. The Manual includes usage and operation guidelines, warnings concerning dangers while operating the ATTO, including when changing from the folded position to the drive position and vice versa, while driving and during transportation of an ATTO.

The purpose of the manual is to get you acquainted with the product and all its capabilities. The manual is aimed at providing you

# Warnings and Cautions

Please pay attention to all cautionary symbols warnings in this Owner's Manual. They are here to help you prevent injuries and damage that may occur if you do not read or choose to ignore the instructions.

## **⚠ WARNING**

Frames include important information concerning your safety and warnings to prevent possible injuries.

## **⚠ CAUTION**

Frames are intended to draw your attention to possible risks or potential damage to your ATTO.

## **📌 NOTE**

Frames highlight some more general information we would like you to take note of.

In this Owner's Manual, you will also find some additional special warnings and cautions as follows:

## **PINCH POINT**

Pinch Point warnings refer to an area where you must pay extra attention to your fingers so they are not pinched between two metal parts.

## **REQUIRES TOOLS**

Wrench warnings (with a wrench symbol) refer to an issue that should be addressed by a certified technician. Please seek a professional or contact Movinglife Support to help you locate a professional near you.



## Users and Certified Technicians

### **▲ WARNING**

THIS CLAUSE CONTAINS MUST-READ INFORMATION CONCERNING USERS AND CERTIFIED TECHNICIANS.

This Owner's Manual contains important information for the safe operation and use of these products. DO NOT use these products or any available optional equipment without first reading and completely understanding these instructions, and any additional instructional material supplied with a product or optional equipment. If you are unable to understand the warnings, cautions or instructions, contact a healthcare professional, an authorized Movinglife dealer, or technical personnel before attempting to use this equipment. Otherwise, injury or damage may occur.

**ATTO Users:** Do not service or operate this equipment without first reading and

understanding this Owner's Manual. If you are unable to understand the warnings, cautions, and instructions, contact Movinglife Technical Support before attempting to service or operate this equipment. Otherwise, injury or damage may occur. Procedures other than those described in this manual must be performed by a qualified technician.

**Movinglife Qualified Technicians:** Do not service or operate this equipment without first reading and understanding the Owner's Manual. If you are unable to understand the warnings, cautions and instructions, contact Movinglife technical support before attempting to service or operate this equipment. Otherwise, injury or damage may occur.

This Owner's Manual is compiled from the latest specifications and product information available at the time of publication. We reserve the right to make changes and updates as they become necessary or available. Any changes to our products may result in slight variations between the illustrations and explanations in this manual and the product you have purchased.

# BACKGROUND

Movinglife's ATTO is an advanced-technology, Class-A Mobility Scooter, designed for use indoors and outdoors. When driving on a sidewalk, you should always follow pedestrian rules. You should give pedestrians priority and show consideration for other sidewalk users, particularly those with a hearing or visual impairment who may not be aware of your presence on a mobility scooter.

In most countries, mobility scooters may be used by a disabled person, a nondisabled person, and anyone demonstrating a vehicle before sale, training a user, or taking the vehicle to or from maintenance or repair. A disabled person in this context is someone with an injury, physical disability, or medical condition that limits their ability to walk or someone who has difficulty walking.

If you are using a mobility scooter for the first time, or if it has been a while since you have driven one, you are strongly advised to get some training to ensure that you can steer and control the vehicle properly, especially on uneven surfaces. Your assessment should include checking your eyesight, reaction time, balance and posture, ability to sit for long periods of time, concentration and ability to get on and off the ATTO. You may also want to consider having a regular review of your driving skills.

Although in most countries there are no legal eyesight requirements, good vision is important for driving a mobility vehicle safely. You should be able to judge distances, recognize obstacles and hazards, and be able to see pedestrians and other road users. Poor eyesight could be a contributing factor in an accident and could render you liable for a compensation claim. Vision can change with age and it is recommended that you have regular sight tests.

If you are eligible to be registered as severely sight impaired (blind), you should not drive a mobility scooter as this would put yourself and others at risk.

If you are eligible to be registered as sight impaired (partially sighted), you should consult your optometrist or doctor.

If you regularly take medication that makes you drowsy, you should consider whether it would be safe to use a Mobility Scooter. If you are in any doubt, consult your doctor. You should not use a mobility scooter if you have been drinking alcohol. ATTO can be used in pedestrian areas; on footpaths, pavements, sidewalks, and bridleways.

Subject to space availability and depending on local regulations, you may be able to travel with your ATTO on busses, airplanes and trains, so long as those vehicles are constructed or adapted to carry a mobility scooter and providing that the ATTO fits onboard.

#### **NOTE**

Laws and regulation may vary from country to country and from state to state. Always check with local authorities to ensure that you can use your mobility scooter and that you understand the local restrictions that apply to you and your ATTO.

## **Certification and Compliance**

The ATTO Mobility Scooter is designed to comply with the following international safety requirements for medical electrical equipment:

Safety: EN 12184 and ISO 7176-15

EMC: ISO 7176-21

Risk Management: ISO 14971

Regulatory Compliance: EEC: Annex V of 93/42/EEC

The European Medical Devices Directive of 93/42/EEC classifies the ATTO Mobility Scooter as a Class I device.

# SAFETY – Safety Highlights



ATTO is not a toy and should not be used by children, unless they are the intended users who comply with laws and regulations and with the minimum requirements specified in the Specifications section of this Owner's Manual.



ATTO is not intended for show-off driving or any other use other than the intended use. This mobility scooter must be used only in areas intended for pedestrians and under conditions allowing safe use and good contact with the ground.



Beware of snow, ice, sleet, rain, strong wind, sand, broken glass and other obstacles and interferences. All those and other such irregularities are dangerous to you and to others, and should be avoided to prevent injury and damage.

## ▲ CAUTION



Do not try to descend or climb an incline with an angle greater than recommended. See the Specifications section of this Owner's Manual.

## ▲ CAUTION

Always climb or descend an incline by driving straight up or straight down the incline.



## ▲ WARNING

Carefully read and adhere to the following safety instructions.

## ▲ CAUTION

**FIRST TIME USER** – Do not operate your ATTO for the first time before reading and completely understanding this Owner's Manual.

## Safety and Usage Instructions

DISCLAIMER: Movinglife Ltd. is not and cannot be held responsible for any damage or injury incurred due to improper or unsafe use of the Movinglife ATTO. Movinglife Ltd. specifically disclaims responsibility for any bodily injury or property damage that may occur during any use that does not comply with applicable federal, state, or local laws or ordinances.

### First Time Users

- Do not use this product or any available optional equipment without first reading and completely understanding these instructions. If you are unable to understand the warnings, cautions or instructions, contact a healthcare professional, an authorized Movinglife dealer, or Movinglife technical support before attempting to use this equipment. Otherwise, injury or damage may occur.
- There are certain situations, including some medical conditions, where the ATTO user will have to practice operating the ATTO in the presence of a trained attendant. A trained attendant can be defined as a family member or care professional especially trained in assisting an ATTO user in various daily living activities. Consult your physician if you are taking any medication that may affect your ability to operate your ATTO safely.
- If you feel uncomfortable with your new ATTO or do not understand the instructions presented in this Owner's Manual, or if, for any reason, you do not feel capable of performing the activities necessary to open, fold, assemble, disassemble, operate, or maintain your ATTO, please contact the authorized Movinglife dealer from whom you purchased this ATTO, or contact Movinglife technical support.

## General

- Always turn the power off when the unit is not in use.
- Always make sure your seat is locked in a fully opened position before driving your ATTO.
- Always remain properly seated when operating your ATTO.
- Use caution when driving on soft or uneven surfaces such as grass and gravel.
- Use caution on decks where there is no railing.
- Turning too sharply around a corner can cause the ATTO to tip over. Always avoid this danger by steering a wide arc around corners and obstacles. To avoid the risk of tipping over, reduce speed before negotiating any turns.
- Never attempt to drive over or off obstacles higher than 20 mm (3/4") when driving forward and 18 mm (45/64") when driving in reverse. This could be unsafe and could damage the ATTO.

- Avoid reaching or bending while driving your ATTO. Bending forward creates the risk of accidental throttle contact. Bending sideways while seated creates the risk of tipping over. It is important to maintain a stable center of gravity and keep the ATTO from tipping over.

## Driving in Public

- Do not ride your ATTO in traffic, on public streets and roadways.
- Be aware that it may be difficult for traffic to see you when you are seated on the ATTO. Obey all local pedestrian and traffic rules. Wait until your path is clear of traffic, and then proceed with extreme caution.
- If the **ON/OFF** button is switched off while driving on a horizontal level plane at the maximum speed (limited by software and subject to local regulation) of 6.4 km/h (4 mph) for the ATTO and 10 km/h (6.2 mph) for the ATTO SPORT, the scooter will come to a stop with a maximum stopping distance of 1.1 m (up to 4 ft) or 2.1 m (up to 7 ft) respectively. ATTO SPORT MAX reaches a speed of up to

8 km/h (5 mph) and has a stopping distance of 1.5 m (5 ft). Please consider this distance when driving. (The ATTO will always be supplied with a speed limitation that is defined according to local regulations.)

- Do not attempt to use your ATTO on stairs or escalators. Always use an elevator.
- Do not operate your ATTO where you cannot safely or legally walk.
- Never operate your ATTO near steps or curbs where you might accidentally drop a wheel off the edge.
- Enter narrow driving paths/doorways slowly and with caution. Always look out for additional obstacles such as car mirrors or doorknobs.

## Sharp Turns

- Avoid sudden starts while the handlebar is turned sharply.
- Do not make a sharp turn or a sudden stop while riding your ATTO.

- Always reduce your speed and maintain a stable center of gravity when turning a sharp corner. Do not turn corners sharply when driving at higher speeds.
- Always reduce the speed of your ATTO when making turns.

## Driving Angles

- Do not attempt to climb ramps, slopes, curbs, or any low-rise slope with an angle greater than the limits specified in the Specifications section.
- When climbing an incline, do not drive at an angle to the incline. Drive your ATTO straight up the incline. This greatly reduces the risk of tipping over or falling.
- For maximum stability, lean forward on your seat while proceeding up ramps, slopes, curbs, or any low rise.
- Drive with caution when attempting to negotiate any incline, even handicap access ramps.

- Do not traverse or drive across the face of a slope.
- Do not attempt to negotiate an incline that is covered with snow, ice, cut or wet grass, leaves, or any other potentially hazardous material.
- Try to keep your ATTO moving when climbing an incline. If you do come to a stop, restart and accelerate slowly and carefully.
- While you are driving down a slope, if your ATTO starts to move faster than you feel is safe, release the thumb lever and allow your ATTO to come to a stop. When you feel that you have gained control of your ATTO again, press the thumb lever and continue safely down the remainder of the slope.
- Do not place your ATTO in Freewheel mode when on an incline or decline.
- Never park on inclines or declines.
- If you must stop on an incline, always lean forward to shift the center of gravity and prevent the ATTO from tipping over backward.

## Reversing

- Make sure that there are no obstacles behind you while reversing your ATTO.
- Do not attempt to have your ATTO move backward down any step, curb, or other obstacle. This may cause the ATTO to fall or tip over.

## Arms and Legs

- When getting on or off your ATTO, do not put most or all of your weight on the edge of the deck. Doing so may cause the ATTO to tip over.
- Do not extend your hands and legs off the ATTO when driving.
- Keep your hands and legs away from the wheels while driving the ATTO. Be aware that loose fitting clothing may get caught in moving parts.
- Always keep your legs on the feet pads while you are seated on your ATTO.



## Weather

- Do not operate or store your ATTO where it will be exposed to rain, snow, mist, or anywhere that reaches below freezing temperature.
- Do not operate your ATTO during stormy weather to reduce the risk of an accident or possible damage to the ATTO.
- Operating in rainy, snowy, salty, or misty conditions, and on icy or slippery surfaces, may have an adverse effect on the electrical system.
- The temperature of ATTO surfaces that can come into direct contact with the driver and/or assistant's skin during normal use and which are within the driver's reach shall not exceed 41°C. The motor surface can reach temperatures greater than 41°C after driving. Do not touch these parts when folding or unfolding the ATTO or wait until the motor has cooled down.

- Do not touch the motor when folding or unfolding the ATTO until the motor has cooled down.
- Do not wash down your ATTO.
- Maintain and store ATTO in a clean, dry condition and avoid exposure to rain, snow, ice, salt, or standing water.

## Power Off

- To prevent injury to yourself or others, always ensure that the power is switched off when getting on or off the ATTO.

## Freewheel

For information on setting the ATTO in Freewheel mode, see the Operating the Freewheel section in this manual.

### **▲ WARNING**

Do not attempt to board or get off the ATTO when it is in Freewheel mode.

Carefully read and adhere to the following safety instructions.

- Always check that the front wheel is engaged (not in Freewheel mode) before driving. Do not switch off the power when the ATTO is still moving forward. This will bring the ATTO to a very abrupt stop.
- Be aware of when the drive wheel is unlocked (Freewheel mode) or locked (Drive mode).
- The drive wheel has to be switched to engaged mode (not in Freewheel mode) while transporting the ATTO. For instructions, see the Freewheel section on page 72.
- Avoid sitting on your ATTO when it is in Freewheel mode.

## Lifting

- Do not attempt to lift or move your ATTO by any of its removable parts including the seat or driving console. Personal injury and damage to the ATTO may result.

## Load

- Never use the ATTO to carry, tow, push, or pull anything but yourself.
- You may use dedicated accessories approved by Movinglife to carry shopping bags and small suitcases and the like only if done according to the instructions and only if the combined weight of the passenger plus load does not exceed the maximum allowed weight of the ATTO.

## Medical Conditions

- Never operate the ATTO while you are under the influence of alcohol.
- Never operate the ATTO if your health condition or medications you are taking cause you to feel dizzy, affect your vision, or affect your ability to safely operate the ATTO in any way.
- Before operating the ATTO, consult your physician if you are taking prescribed medication or if you have any physical limitations that could affect your ability to operate a mobility scooter. Some medications

and limitations may impair your ability to operate the ATTO in a safe manner.

## External Devices

- Contact with tools can cause electrical shock.
- Do not connect or allow anyone except an authorized Movinglife representative to connect any electrical or mechanical device to your ATTO. Unauthorized accessories will void the warranty and may cause damage or injury.

## Unusual Usage

- Never try to use your ATTO beyond its limitations as detailed in this Owner's Manual.
- Never sit on your ATTO while it is in a moving vehicle.
- Never sit on your ATTO when it is being used in connection with any type of hoist or elevation product. Your ATTO is not designed with such use in mind and Movinglife is not liable for any damage or injury incurred from such use.

- Programming of the controller must only be carried out by authorized personnel. Incorrect programming can result in safety hazards for the driver.

## Battery and Charger

- Do not allow unsupervised children to play near this equipment while the batteries are charging.
- Never charge a frozen battery.
- If you encounter a damaged or cracked battery, immediately enclose it in a plastic bag and call your authorized Movinglife dealer for recycle and disposal instructions.
- Avoid damaging AC and DC cords.
- Do not connect an extension cord to the battery charger.
- Use only original Movinglife Li-Ion battery.
- Use only original Movinglife charger.
- The battery is customized for ATTO, ATTO SPORT and ATTO SPORT MAX.
- We recommend you do not charge the battery unattended.

## Modifications

This product has been designed and engineered to provide maximum utility. However, under no circumstances should you modify, add, remove, or disable any part or function of your ATTO. Personal injury and damage to the ATTO may result.

1. Do not modify your ATTO in any way not authorized by Movinglife.
2. Do not use accessories if they have not been tested or approved by Movinglife. Movinglife will not be held responsible for any damage or injury that may occur when using the ATTO with accessories that were not provided or approved by the manufacturer.
3. Get to know the feel of your ATTO and its capabilities. We recommend that you perform a safety check before each use to make sure your ATTO operates safely.

## Weight Limitation

1. Please refer to the Specifications Table for weight capacity information (pg 86).
2. Keep within the specified weight capacity for your ATTO. Exceeding the weight capacity voids your warranty. The manufacturer will not be held responsible for injuries or property damage resulting due to failure to observe weight limitations.
3. Do not carry passengers on the ATTO. Carrying passengers on the ATTO may affect the center of gravity, resulting in tipping over or falling.

## Temperature

1. Some parts of the ATTO are susceptible to change in temperature. The controller can operate in temperatures that range between  $-20^{\circ}\text{C}$  ( $-4^{\circ}\text{F}$ ) and  $50^{\circ}\text{C}$  ( $122^{\circ}\text{F}$ ) only.
2. At extremely low temperatures, the batteries may freeze, and your ATTO may not operate. At extremely high temperatures, your ATTO may operate at slower speeds due to a safety feature of the controller that prevents damage to the motors and other electrical components.
3. ATTO surface temperatures can increase or decrease when exposed to external sources of heat or cold (e.g. sunlight, outdoor environment).

# Safety Labels

The following safety symbols are used on ATTO to identify warnings, mandatory actions and prohibited actions. It is very important that you read and understand them completely.



Place unit on level ground when changing from “D” Drive mode to “N” Freewheel mode or Freewheel mode to Drive mode.  
 N = Unlocked/freewheel.  
 D = Locked/Drive mode.



**Do not lift handle while seated**

Do not lift any handle so marked while seated on ATTO.



**Pinch Point**  
 Do not lift handle while product is unfolded

Marked handle is not intended for product lifting.

**Trolley may topple**



ATTO may topple when not in Parking mode.



**Do not lift handle while seated**

Do not lift with the handle when someone is seated on the vehicle.



**Pinch Point**

Module Weight: 12Kg

Indicates front module weight in kilograms.



For Indoor Use



Do not sit in scooter when traveling in motor vehicle



Do not stand when riding scooter

**Max. Load: 120Kg / 265Lbs**

Driving Restrictions:  
 See warnings in user manual

Module Weight: 17Kg

Indicates ATTO's maximum user weight capacity. Indicates rear module weight in kilograms.

**Pinch Point**



Pinch/Crush points created during the operation of ATTO (opening, closing, assembly, and disassembly).



ATTO/ATTO SPORT



ATTO SPORT MAX

Indicate ATTO's maximum user weight capacity.  
The maximum weight capacity for ATTO SPORT MAX is 136 kg (300 lb.)  
Reduce speed to minimum when approaching an incline or a turn.  
Avoid ascending or descending ramps, curbs or slopes greater than 6 degrees.  
Avoid sharp turns or sudden stops.

## Damaged Labels

In case labels are unreadable for any reason, please consult this section and contact Movinglife for a new set of labels.

## Compliance and Warning Labels

The ATTO Mobility Scooter system components are equipped with various product compliance labels and icons. These are strategically positioned to provide important information regarding safe operation of the system.

For a description of the labels and symbols used as well as details of their location, refer to the following:

- Safety Rating and Manufacturer Identification Label on page 29.
- Warnings and Cautions on page 15.

### **NOTE**

Additional labels used on system controls, accessories and disposables are illustrated and described in the following section:

- Labels on ATTO Mobility Scooter Controls on page 29.

## EMC Information

It is very important that you read this information regarding the possible effects of electromagnetic interference on your ATTO.

### Electromagnetic Interference (EMI) from Radio Wave Sources

Mobility scooters may be susceptible to electromagnetic interference (EMI), which is interfering electromagnetic energy (EM) emitted from sources such as radio stations, TV stations, amateur radio (HAM) transmitters, two-way radios, and cellular phones. The interference (from radio wave sources) can cause the mobility scooter to release its brakes, move by itself, or move in unintended directions. It can also permanently damage the mobility scooter control system. The intensity of the interfering EM energy can be measured in volts per meter (V/m). Each mobility scooter can resist EMI up to a certain intensity. This is called the "EMI immunity level". The higher the EMI immunity level, the greater the protection from EMI. Currently the ATTO technology has an immunity level of at



least 20 V/m, which provides useful protection from the more common sources of EMI.

There are several sources of relatively intense electromagnetic fields in the daily environment. Some of these sources are obvious and easy to avoid. Others are not apparent, and exposure is unavoidable. However, we believe that by following the warning listed below, your risk to EMI will be minimized.

The sources of radiated EMI can be broadly classified into three types:

- 1) Hand-held portable transceivers. These are transmitter-receivers with an antenna mounted directly on the transmitting unit. These devices include citizens band (CB) radios, walkie-talkies, security, fire and police transceivers, cellular telephones, and other personal communication devices.

**NOTE**

Some cellular telephones and similar devices transmit signals while they are on, even when not in use.

- 2) Medium-range mobile transceivers, such as those used in police cars, fire trucks, ambulances and taxis. These usually have the antenna mounted on the outside of the vehicle.
- 3) Long-range transmitters and transceivers, such as commercial broadcast transmitters (radio and TV broadcast antenna towers) and amateur (HAM) radios.

**NOTE**

Other types of hand-held devices, such as cordless phones, laptop computers, AM/FM radios, TV sets, CD players, cassette players, and small appliances such as electric shavers and hair dryers are usually not likely to cause EMI problems to your ATTO.

## Mobility Scooter Electromagnetic Interference (EMI)

Because EM energy rapidly becomes more intense as one moves closer to the transmitting antenna (source), the EM fields from hand-held radio wave sources (transceivers) are of special concern. It is possible to unintentionally bring high levels of EM energy very close to the mobility scooter control system while using these devices. This can affect the mobility scooter's movement and braking.

Therefore, the warnings listed below are intended to prevent possible interference with the control system of the ATTO. Electromagnetic interference (EMI) from sources such as radio and TV stations, amateur radio (HAM) transmitters, two-way radios, and cellular phones can affect mobility scooters.

Following the warnings listed below should reduce the chance of unintended brake release or scooter movement, which could result in serious injury.

- Exercise caution when using hand-held transceivers (transmitter-receivers), such as citizens band (CB) radios or personal communication devices (such as cellular phones) while the ATTO is turned ON.
- Be aware of nearby transmitters, such as radio or TV stations, and try to avoid getting close to them.
- If unintended movement or brake release occurs, turn the ATTO OFF as soon as it is safe.
- Be aware that adding accessories or components, or modifying the ATTO, may make it more susceptible to EMI

**NOTE**

There is no easy way to evaluate their effect on the overall EMI immunity of the ATTO.

- Report all incidents of unintended movement or brake release to the ATTO manufacturer and note whether there is a source of EMI nearby.

**Important**

EMI/RFI – ATTO has passed an EMI immunity test according to EN 60601-1 Class B.

Modification of any kind to the electronics of the ATTO as manufactured by Movinglife may adversely affect the EMI immunity levels.

The operation of the ATTO might disturb the operation of devices in its environment due to emitting of electromagnetic fields (e.g. alarm systems of shops, automatic doors, etc.).

**Radiation**

The ATTO Mobility Scooter does not generate any hazardous radiation.

# ATTONOMY

## Features available for both ATTO and ATTO SPORT



---

Figure 1 - ATTO in Folded mode

---



Figure 2 - ATTO in Drive mode



---

Figure 3 ATTO in Trolley mode

---

## Features for both ATTO SPORT and ATTO SPORT MAX only



Front disk brake for extra safety



Rich information LCD display / USB charger



Extra wide rear wheel



Rear light lifting handle



Powerful LED Headlights



Shock-absorbing airless NPT tires



Regenerative braking control system



Anti-theft wireless key fob

# OPERATING ATTO

ATTO is very easy to operate; it requires no special skills. Learn how to operate your ATTO by following the steps described in the following pages and by practicing. The illustrations and instructions pertain to both the ATTO and the ATTO SPORT Mobility Scooters.

The first step is to read through this section of the Owner's Manual and understand the sequence of steps required for opening and closing (folding) the ATTO. Once completed, use the manual to guide you while you practice each step. It may be difficult at first, but it will become very easy once you have practiced it several times.

To support easy visual learning, we have created a simple video, which is available to watch under the videos section of our website:

[www.movinglife.com/videos](http://www.movinglife.com/videos)

## **⚠ WARNING**

Injury hazard due to improper assembly, disassembly, opening or closing of ATTO. Ensure that all components in the ATTO have been correctly placed before continuing to the next step. Always check that all locked devices are safely secured.



## Opening

1. Position your ATTO on a flat surface before opening. Make sure you have clearance of 2 meters (7 feet) from the side of the rear wheels.

### ▲ CAUTION

Operations described below are done near and around pinch points. Be careful and follow instructions to prevent injury. Make sure you keep your fingers away from moving parts that may close during opening.

2. Release the adjustment lever of the handlebar (see Figure 4, step 1) and bring the handlebar to an upright position (see Figure 4, step 2), then bring the lever back to its secured position (see Figure 4, step 3).

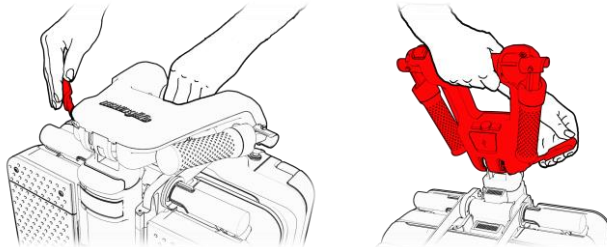

Figure 4

3. Press the central release button until it clicks and remains pressed (see Figure 5).

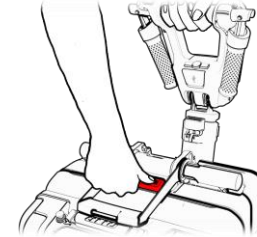

Figure 5

4. Press the red button (see Figure 6, step 1) and tilt it away from the main ATTO body (see Figure 6, step 2).

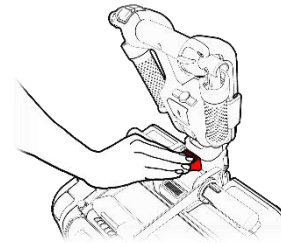
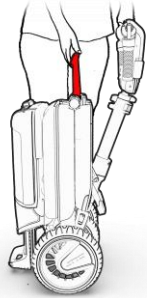

Figure 6

5. Hold ATTO by both the main handle and the handlebar (see Figure 7).



---

Figure 7

---

6. Tilt your ATTO toward the rod until the front wheel touches the ground (see Figure 8).

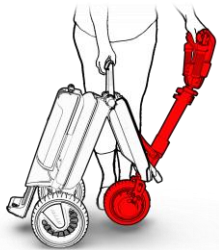

---

Figure 8

---

7. Using the main handle, pull the main body away from the rod, thus rolling the rear wheels away from the front wheel (see Figure 9).

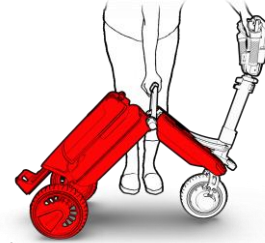

---

Figure 9

---

Gently push the handle down until ATTO's base is flat (see Figure 10).

Keep holding the rod at an upright position.

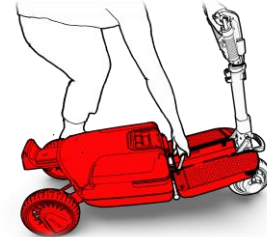

---

Figure 10

---

8. Place the handle in its designated place (see Figure 11).

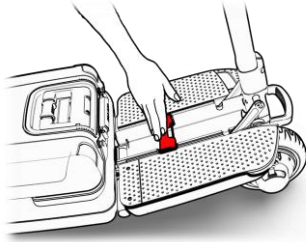

---

Figure 11

---

9. Lock the rod in the upright position by pushing the front lever down until it clicks and locks in place (see Figure 12, step 1). In case the front lever requires significant force to operate, you should apply horizontal pressure on the main handle toward the front of the ATTO (see Figure 12, step 2). This will release pressure on the front lever and will make it easier to lock (see Figure 12, step 3).

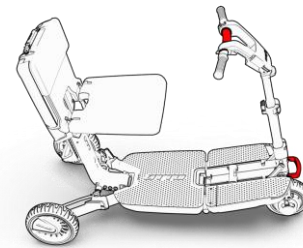
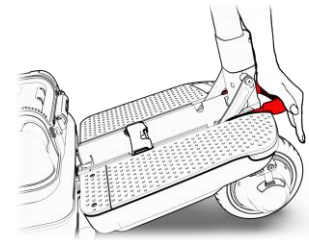

---

Figure 12

---

10. Place one hand on the tiller, and with the other hand, release the secure lever of the back handle (Figure 13, step 1) and bring the handle to an upright position of 90 degrees (Figure 13, step 2).

**NOTE**

For proper operation, do not flip the handle to 180 degrees from a closed position. If you do and are unable to lift the chair backward, return the handle to its original position and try again.

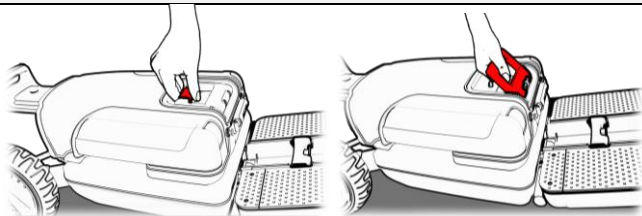

Figure 13

- Using the handle, pull the back of the chair backward until it clicks and locks in place (see Figure 14).

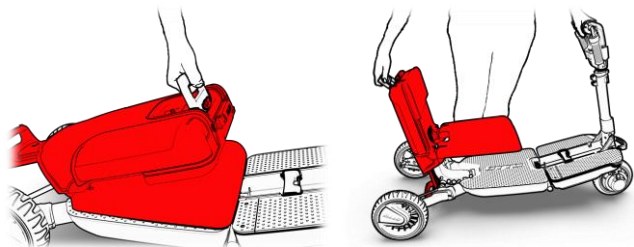

Figure 14

11. Continue using the handle to pull up the chair until it clicks and locks in place (see Figure 15).

**WARNING**

Do not sit on the seat before it clicks into place to prevent it from sliding down again.

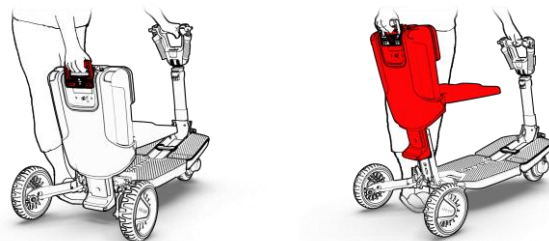

Figure 15

12. Open both sides of the handlebar (see Figure 16).

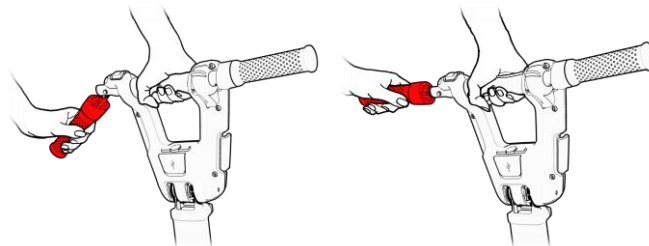

Figure 16

## Installing the Battery

To install the battery, insert the back end of the battery first (See Figure 17, step 1) and then push the front until the battery clicks and locks in place (See Figure 17, step 2).

### NOTE

Make sure the battery is properly connected before folding ATTO or turning it on.

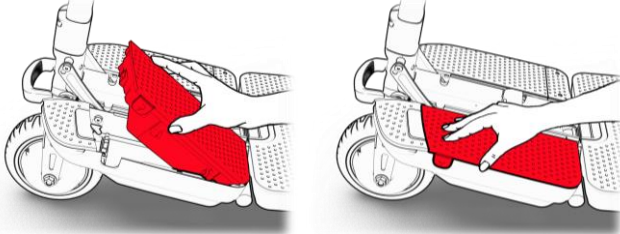

Figure 17

## Removing the Battery

Identify the battery release button (see highlighted in red in Figure 18).

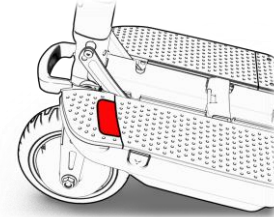

Figure 18 - Battery release button

To remove the battery from your ATTO, press the release button (see Figure 19, step 1) and pull the battery out (see Figure 19, step 2).

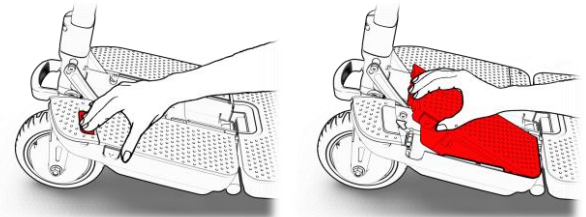

Figure 19

Use the battery's handle for carrying the battery when it has been removed from the ATTO (see Figure 20).

**NOTE**

ATTO SPORT/ATTO SPORT MAX include the XL battery, which does not feature a handle.



Standard Flight Battery

XL Flight Battery

Figure 20

**WARNING**

- NEVER recharge the battery by attaching cables directly to battery terminals.
- DO NOT recharge the battery and operate ATTO at the same time.
- DO NOT recharge the battery when ATTO has been exposed to any type of moisture.
- DO NOT sit on ATTO while recharging the battery.

**WARNING**

- A new battery MUST be fully charged prior to initial use of ATTO. ALWAYS fully charge a new battery before initial use or your battery life will be reduced.
- As a general rule, you should charge your battery to 60% of full charge before placing it in storage for a long period of time.
- Use only a charger approved by Movinglife.

Charging the battery can be done onboard and offboard. This means that you can connect the charger when the battery is either attached or detached from the ATTO.

## Adjusting for Maximum Comfort

Several adjustments can be made for maximum comfort. Some adjustments can be made by the user, while other adjustments **must only be made by a certified technician**. The adjustments that can be made by the user are specified in detail in this section.

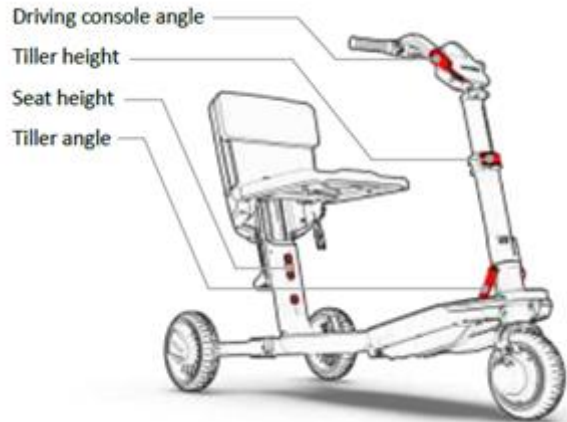

Figure 21 Comfort adjustments

### PINCH POINT

Operations described below are performed near and around pinch points. Be sure to follow instructions to prevent injury. Make sure you keep your fingers away from moving parts that may close during adjustments.

### Adjusting Driving Console Height

Open the rod height lever and hold it (Figure 22, step 1) while you adjust the height of the handlebar to your preferred level (Figure 22, step 2). Bring the lever back to the secure position (Figure 22, step 3).

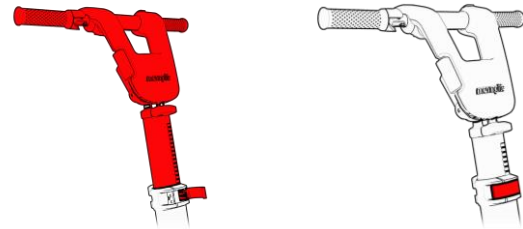

Figure 22 Rod height lever

## Adjusting Driving Console Angle

ATTO's driving console can be adjusted for your comfort. To adjust the driving console, you should first be seated on your ATTO:

1. Hold the driving console in one hand and release the adjustment lever using the other hand (see Figure 23, step 1).
2. Adjust the driving console angle so that you can reach and hold it comfortably with a clear view of the display area (see Figure 23, step 2).
3. Tighten the adjustment lever once you're satisfied with the angle (see Figure 23, step 3).

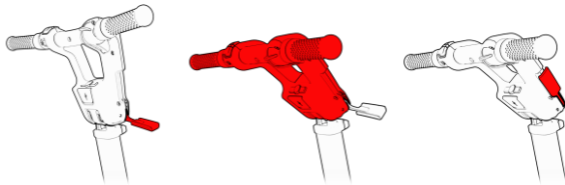

Figure 23 Driving Console tilt adjustment

## Seat Height Adjustment

### REQUIRES TOOLS

It is recommended that adjusting seat height be performed by certified technicians to reduce injury and damage.

Although ATTO's seat is slim and stylish, it was designed to provide comfort and safety and can be adjusted according to user's preferences. The seat mechanism can be locked at one of four fixed heights. To adjust seat height, please follow the following steps:

1. ATTO must be in an opened position to adjust the seat height. Lift the seat to an upright position, locate the seat height adjustment cover, which is at the base of seat right under the seat pivots, and remove it by pressing on two side spots with a screwdriver (see Figure 24, step 1).



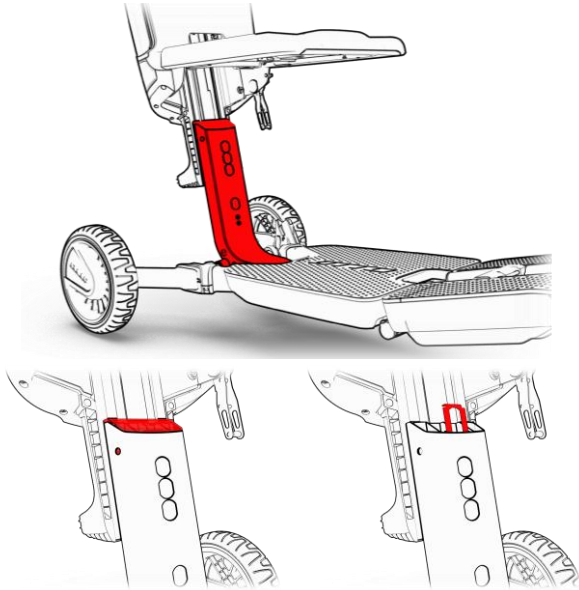

Figure 24 Seat height cover

2. Under the cover you will find a metal bracket that has to be removed. Hold the bracket between your fingers and lift it out. Remember the bracket's position to make it easier to put it back in place again (see Figure 24, step 2).
3. Once the bracket is removed, you should be able to remove the bulky metal pin (located in

one of the four adjustment holes). Keep holding the seat in its place! Remove the pin while holding the seat with your other hand (see Figure 25, step 3).

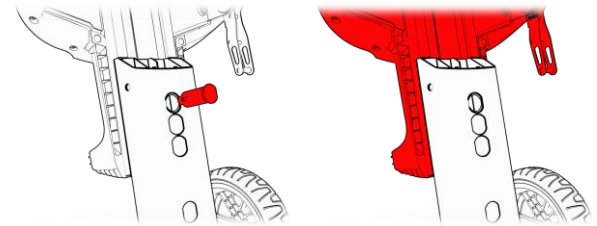

Figure 25 Seat height adjustment holes

4. Now you can adjust the seat height to any of the four holes and reinsert the pin to hold it in place (see Figure 25, step 4).
5. **DO NOT FORGET** to reinsert the metal bracket and the cover.

**⚠ WARNING**

When the seat is in its highest position, the ATTO will be more inclined to tip over.

## Tiller Angle Adjustment

### REQUIRES TOOLS

The tiller angle adjustment must be performed by certified technicians only, to prevent injury and damage.

The tiller (steering rod) angle can be adjusted in one of two positions according to user comfort. The default position will be adequate for most users, while larger users may want the tiller positioned further away from their body to provide more space. For smaller users, the tiller can be positioned closer using special parts (ask your local dealer). You will require a 4 mm Allen wrench (hex key) to adjust the angle.

1. Your ATTO must be in an open position to adjust the tiller angle. Once opened, locate and release the two Allen (hex) screws (see highlighted in red in Figure 26). Make sure you keep holding the tiller in an upright position (you must hold the tiller to prevent it from falling while releasing the screws).
2. Move the tiller into the desired position and tighten the two screws back again using a thread-locker (such as Loctite).

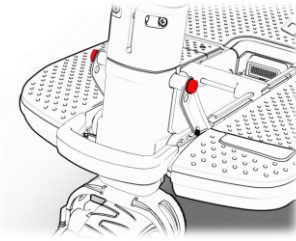

Figure 26 Tiller angle adjustment screws

## Driving Console

The driving console (your ATTO dashboard) contains all the controls and displays needed for operating your ATTO while driving.



ATTO

ATTO SPORT / ATTO SPORT MAX

Figure 27 Driving Console overview

## ON/OFF and Speed Control Buttons

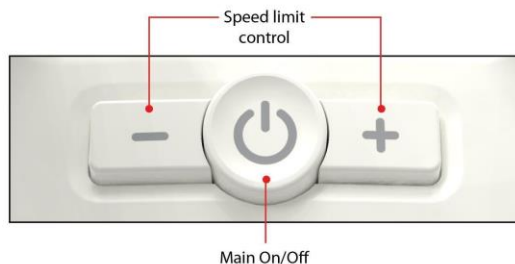
Figure 28 **ON/OFF** and speed control

- A. The **ON/OFF** button is located at the center of the driving console below the display power panel. To turn ATTO on, press and

hold the **ON/OFF** button until your ATTO starts.

- B. The two buttons on either side of the **ON/OFF** button marked "+" and "-" are your speed limit control. Along with the number shown on the display panel, they allow you to set the maximum speed ATTO will attain at full throttle. While the ATTO is not moving, click the "+" button to increase the speed and the "-" button to decrease the speed.

### **⚠ WARNING**

When driving in crowded places and near obstacles, use extra care and reduce the maximum speed to a limit that allows you to control your ATTO without presenting a risk to other people and to yourself.

### **📌 NOTE**

ATTO and ATTO SPORT will automatically shut down when left idle for 20 minutes.

## Display Panel

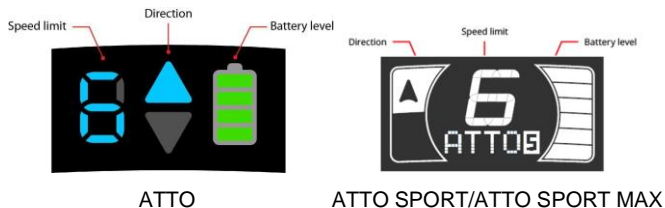

Figure 29 Display Panel

## Menus (ATTO SPORT)

Holding down the **ON/OFF** and “+” buttons together will initiate the menu display. To switch between the different menus, click and hold the **ON/OFF** button, while clicking the “+” button to change modes. To exit the menu display, hold down the **ON/OFF** button for 5 seconds. The scooter will turn off. Press the **ON/OFF** button once again to turn the scooter back on.

For further details please refer to the Movinglife website: [www.movinglife.com](http://www.movinglife.com).

**Battery level meter** – When ATTO power is on, the battery meter indicates the *approximate* battery charge level. As with all Lithium-Ion batteries, the charge level indication is only 100% accurate when the battery is fully charged. All other indications are approximate and intended to give you a rough idea

of the battery charge level. Please refer to the Specifications section in this Owner's Manual for more information on your battery range.

### NOTE

Your ATTO will automatically turn itself off if the battery output falls below operation voltage.

Direction mode – ATTO can drive both forward and backward. The current driving direction is shown on the display panel by an arrow pointing forward or backward, depending on your selection. To switch the driving direction, press on the **Direction** button located near the left-hand grip.

## Throttle

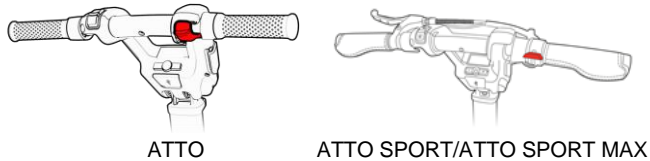

Figure 30 Driving throttle

The throttle is used for driving and controlling the driving speed. Place your thumb on the throttle lever and press it down to accelerate. To decelerate, release the throttle lever to your level of comfort. To bring the ATTO to a complete stop simply remove your thumb from the lever which will set the lever to its “OFF” position, bringing the ATTO to a halt.

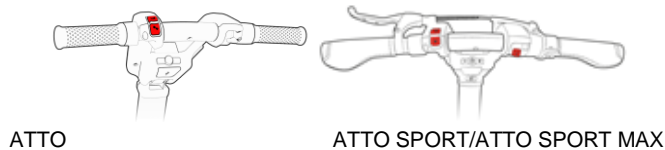

Figure 31 Reverse and Horn buttons

- A. ATTO is equipped with a **Driving Direction** button. Press on the button to change the driving direction. Once the driving direction has changed, ATTO will sound a single beep when in Forward Drive mode, and a double beep when in Reverse Drive mode. In addition, a large arrow on the display panel will indicate the current driving direction. When turning ATTO on it will by default be in forward Drive mode.
- B. Press the **Horn** button to sound the horn. Always use the horn when needed to prevent accident or injury.
- C. ATTO SPORT only: Press the **Lights** button to switch on the headlights. If you turn off the scooter while the lights are on, by default, they will be turned off when you restart the scooter.



## ▲ WARNING

Always bring the ATTO to a full stop before changing the driving direction.

## USB Port

ATTO is equipped with a general USB charging port which provides a charging current of up to 1A. If an error occurs, the port will automatically be disabled, and the ATTO will continue to operate as normal. The error will be reset after restarting the ATTO's controller (power off/on cycle).

## Display Dimming

Pressing the "+" and "-" buttons simultaneously will toggle the dimming option.

## Beep Sounds

Beeps caused by pressing buttons can be enabled or disabled. To enable, press the "+" and **Horn** buttons simultaneously. To mute the beeps, press the "-" and **Horn** buttons simultaneously. (The horn is always active.)

## Handlebar Grips

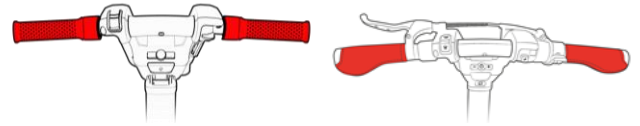

ATTO

ATTO SPORT/ATTO SPORT MAX

Figure 32 Handlebar grips

There are two grips on the handlebar, one on each side. To change the grips from folded position to drive position simply lift the grip around its pivot and it will lock itself in the open position. To fold it back again (only when you are about to fold ATTO), simply pull the grip away from the handlebar and push it down to an angle of almost 90 degrees. It will automatically lock itself in the folded position. (see Figure 37, page 62)

## Adjusting the Handlebar Grips (ATTO SPORT)

You can easily adjust the handle's angle. To do so, you will need a number 3 Allen key (AKA Hex key). Loosen the screw on the clasp, adjust to the desired angle, and tighten the screw until it is locked.

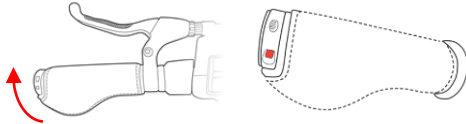

ATTO SPORT/ATTO SPORT MAX

### **PINCH POINT**

Be careful of pinch points near the grip hinge. To prevent injury, keep your fingers away from metal parts and hold the grip and the handlebar only in non-exposed areas covered with plastic and rubber.

## Getting On ATTO

- Verify that the ATTO is turned off.
- Verify that the ATTO is fully opened and secured. See the Opening section of this Owner's Manual.
- Carefully place one foot on the center of the deck and seat yourself comfortably and securely on the seat.

### **▲ WARNING**

Do not lean on the handlebar tiller for support while stepping on or off the ATTO. The handlebar might unintentionally move and cause you to lose your balance, which could result in personal injury.

### **▲ WARNING**

Never step on or off the ATTO using the seat or the backrest for support. The backrest may fold down and may cause you to lose your balance, which could result in personal injury.

## ATTO SPORT Front Handle Brake

ATTO SPORT is equipped with an additional, manually operated front handle brake. Squeezing the lever activates the brakes. However, the lever is not necessary to stop the scooter. The scooter will stop when the thumb pressure is released from the throttle (see pages 21 and 60 for more on stopping). While the manual brake lever is activated, the throttle is disabled.

## Getting Off ATTO

- Verify that the power is turned off.
- Carefully place one foot on the ground, transfer your weight to that leg, and slowly come to a standing position.
- Safely walk away from the ATTO.



## Driving

### NOTE

#### INSPECTIONS PRIOR TO USING YOUR ATTO:

1. Check that the battery is in place and verify that it is locked securely and not protruding above the surface.
2. Check that the battery is fully charged with capacity to carry you to your destination.
3. Verify that the freewheel lever is locked.
4. Verify that all locking parts are fully secured and locked in place.

### Turning ATTO On

Press and hold the **ON/OFF** button to turn ATTO on. All lights will come on momentarily and the following information will be indicated (see Figure 33):

- Define speed to suit terrain
- Forward driving direction (default)
- Battery charge level status



ATTO



ATTO SPORT / ATTO SPORT MAX

Figure 33 Typical display after switching on

- We recommend that you select a maximum speed setting (using the "+" and "-" buttons on either side of the **ON/OFF** button) at which you feel comfortable, safe, and fully in control of your ATTO.
- Make sure that you are seated safely and properly on your ATTO.
- For your first driving sessions, make sure that your ATTO starts out on a level surface and that you will continue driving on a level surface.

### WARNING

- Never touch the freewheel/brake release lever while driving.
- Do not bend, lean, or reach for objects while driving ATTO.
- Movements may change your center of gravity and the weight distribution of the ATTO and cause your ATTO to tip over, possibly resulting in personal injury.
- Never switch the ATTO to the Freewheel mode when somebody is sitting on it.
- For proper operation, the freewheel/brake release lever should always be in "D" Drive mode.
- Always bring your ATTO to a complete stop before stepping on or off the ATTO.

## Ignition Using the Remote Key Fob (ATTO SPORT)

Clicking the **Unlock** button on the key fob will activate the scooter and disable any previous locking carried out with the remote. See page 75 for more information on using the Remote Key Fob.

## Forward Driving

- Place your hands on the handgrips. Adjust the tiller to the center position to drive straight forward.
- Make sure you are in forward Drive mode by looking at the Direction Arrow on the display. If the arrow is pointing forward (away from your body), then you are in Forward mode. If the arrow is pointing backward (in the direction of your body), then you should press the **Direction** button until you hear one beep and see that the Direction Arrow has been reset and is now pointing forward.
- Use your right thumb to operate the drive throttle. Press the throttle lightly to move forward.
- Use your left thumb when the throttle is on the left side.
- Increase the pressure applied by your thumb to increase your speed.

- To stop the ATTO, release all pressure on the throttle. The throttle will automatically return to the upper (off) position and your ATTO will come to a gradual stop.

### NOTE

Always bring your ATTO to a full stop before switching directions from forward to backward and vice versa.

## Reverse Driving

- Place your hands on the handgrips.
  - Use one of your fingers to press the **Direction** button located on the left side of the driving console.
  - You should hear a double beep confirming that you are now driving backward. If you hear a single beep you are in forward Drive mode and should press the **Direction** button again.
  - Use your right thumb to operate the drive throttle. Press the throttle lightly to move backward.
  - Increase the pressure applied by your thumb to increase your reverse speed.
  - To stop ATTO, release all pressure on the throttle. The throttle will automatically return to the upper (off) position and your ATTO will come to a gradual stop.
- Note that for safety reasons, ATTO's speed in reverse is slower than the maximum speed limit set on the speed control dial.

## Cruise Control (ATTO SPORT Only)

Pressing “+” and “-“ simultaneously while squeezing the throttle will activate the scooter's automatic Drive mode (Cruise Control). This tells the scooter to travel consistently at the last speed determined by the driver without having to activate the throttle. Cancel Cruise Control by pressing any button, the manual brake lever or the throttle lever. Note: Before switching to Cruise Control mode, make sure the path ahead is clear and the defined speed is suitable for its conditions.

To slow down and stop, just let go of the drive throttle, and it will return to the upper (off) position. The ATTO automatically brakes using the regenerative brake. This should be followed by entering the ATTO into Parking mode using the electro-mechanical brake.

The manual front handle brake on the ATTO SPORT is an addition to the above and not a replacement.

## Emergency Braking

In case you must stop, and you have released the drive throttle but your ATTO continues to move, press the **ON/OFF** button until the ATTO turns off and stops.

On the ATTO SPORT, you can use the front handle brake to stop abruptly in case of emergency.

## Steering

- Steering your ATTO is easy and intuitive.
- With both hands on the handgrips of the tiller, turn the tiller to the right or to the left to define the driving direction accordingly.
- Make certain to maintain enough distance when turning your ATTO so that the rear wheels safely clear any obstacles.

### **WARNING**

Turning too sharply around a corner can cause the ATTO to tip over. Avoid this danger by steering a wide arc around corners and obstacles. Also, to avoid the risk of tipping over, reduce speed before negotiating any turns.

## Steering in a Tight Spot

If you must steer in a tight spot, such as entering a doorway or when turning around:

- Bring your ATTO to a full stop.
- Turn the speed control to the slowest speed setting.
- Turn the tiller to the direction in which you wish to drive.
- Press gently on the thumb throttle and slowly negotiate your ATTO through the tight spot or turn.

## Steering in Reverse

When backing up your ATTO please practice extra caution and pay special attention to your actions:

- Use a finger to click the **Direction** button. You should hear a double beep confirming that you are now driving backward.
- Turn the tiller in the direction in which you wish to drive backward.
- Note that for safety reasons, ATTO's speed in reverse is slower than the maximum speed limit set on the speed control dial.

## Driving on Slopes

### **▲ WARNING**

Stopping distance on slopes can be significantly greater than on level ground

More and more buildings have ramps with specified degrees of inclination, designed for easy and safe access. Some ramps may have switchbacks (180 degrees turn) that require you to have good cornering skills on your ATTO.

- Proceed with extreme caution as you approach the downgrade of a ramp or other incline.
- Take wide swings with your ATTO around any tight corners. If you do that, the ATTO's rear wheels will follow a wide arc, not cut the corner short, and not bump into or get hung up on any railing corners.
- When driving down a ramp, keep ATTO's speed fixed at the slowest speed setting to ensure a safe and controlled descent.
- Avoid sudden stops and starts.

When climbing an incline, try to keep ATTO moving. If you must stop, start up again slowly, and

then accelerate cautiously. When driving down an incline, do so by adjusting the speed to the slowest setting and driving in the forward direction only. If your ATTO starts to move down the incline faster than you anticipated or desired, allow it to come to a complete stop by releasing the throttle. Then push the throttle forward slightly to ensure a safe and controlled descent.

### **▲ WARNING**

When climbing an incline, do not zigzag or drive at an angle up the face of the incline. Drive your ATTO straight up the incline. This greatly reduces the possibility of tipping over or falling. Always exercise extreme caution when negotiating an incline.

### **▲ WARNING**

Do not drive your ATTO across the side of an incline or diagonally up or down an incline. Avoid stopping, as much as possible, while driving up or down an incline.

**NOTE**

ATTO will automatically slow down when detecting a steep slope.

**WARNING**

Any attempt to climb or descend a slope steeper than that shown in Figure 34 may make ATTO unstable and cause it to tip over, resulting in personal injury.

**WARNING**

You should not travel up or down a potentially hazardous incline (i.e., areas covered with snow, ice, cut grass, or wet leaves).

**WARNING**

When on any sort of an incline or decline, never place the ATTO in Freewheel mode while seated or standing next to it.

**WARNING**

Even though your ATTO is capable of climbing slopes greater than that illustrated in Figure 34, do not, under any circumstances, exceed the incline guidelines or any other specifications presented in this manual. Doing so could cause

your ATTO to become unstable, resulting in personal injury and/or damage to your ATTO.



Figure 34 Maximum recommended incline angle

When approaching an incline, it is best to lean forward (see Figure 35 and Figure 36). This shifts the center of gravity of you and your ATTO toward the front of the ATTO and improves stability.



Figure 35  
Normal driving position



Figure 36  
Shifts center of gravity

## Turning Corners

Turning at high speed may cause your ATTO to tip over. Factors affecting the possibility of tipping over include turning speed, steering angle (how sharply you are turning the steering tiller), uneven road surfaces, inclined road surfaces, a transition from low grip area to high grip area (such as moving from a grassy surface to a paved surface – especially at high speed while turning), and abrupt changes of direction. High-speed turning is not recommended. If you feel you are about to tip over while turning, reduce speed and your steering angle (i.e., make the turn wider) to prevent your ATTO from tipping over.

ATTO SPORT will automatically reduce speed when turning a corner if you are travelling at a speed over 6 km/h (3.7 mph).

### **▲ WARNING**

When you turn a sharp corner, reduce speed. When you use the ATTO at a high speed, do not make sharp turns. This will reduce the risk of overturning and falling. Always exercise discretion when taking a turn to avoid injury and damage to property.

## Folding (Closing)

1. Make sure ATTO is on flat ground before folding it.

### **PINCH POINT**

Operations described in this section are done near and around pinch points. Be careful to follow instructions to prevent injury. Make sure you keep your fingers away from moving parts that may close while during folding.

2. Fold down both sides of the handlebar (see Figure 37).

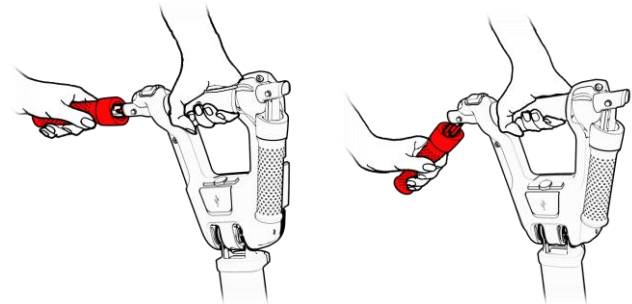

Figure 37

3. Release the secure lever of the back handle (See Figures 38 and 39, step 1) and bring the handle to 100 degrees position (See Figures 38 and 39, step 2). Allow the seat to slide down until it clicks in place (See Figures 38 and 39, step 3).



---

Figure 38

---

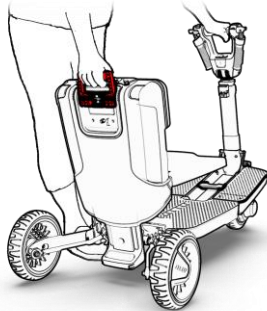

---

Figure 39

---

4. Push the back of the chair forward until it clicks (see Figure 40).

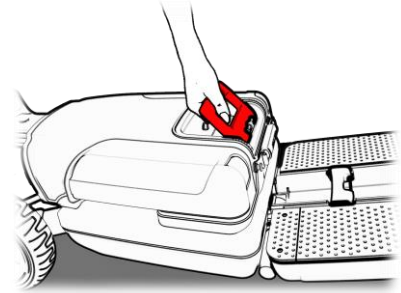

---

Figure 40

---



5. Use one hand to keep the rod upright, and with your other hand, release the front lever (see Figure 41, step 1). In case the front lever requires a significant amount of force to operate, apply horizontal pressure on the main handle toward the front of the ATTO (see Figure 41, step 2). This will release pressure on the front lever and will make it easier to open (see Figure 41, step 3).

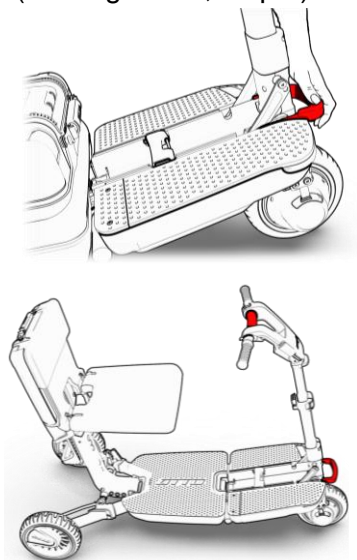

---

Figure 41

---

- Switch hands. Use one hand to keep the rod upright and use your other hand to lift the main handle (see Figure 42).

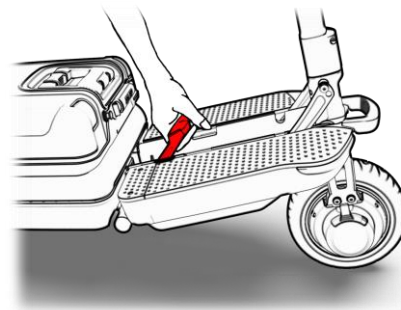

---

Figure 42

---

6. Use the main handle to pull the center upward and toward the rod (See Figure 43, step 1) until it clicks and locks in place (See Figure 43, step 2).

### **PINCH POINT**

Be careful not to pinch your finger between the chassis. This area is a pinch point and requires your full attention.

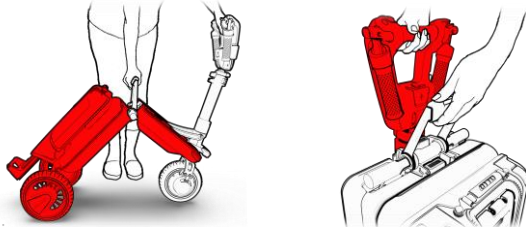

Figure 43

7. Pull the rod height lever (see Figure 44, step 1) to adjust the height of the handlebar to the lowest position and bring the lever back to the secure position (see Figure 44, step 2).

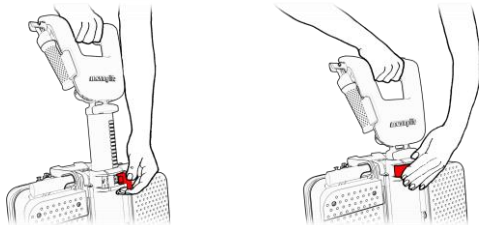

Figure 44

8. Release the adjustment lever of the handlebar (see Figure 45, step 1) and bring the handlebar to a horizontal position (see Figure 45, step 2). Then bring the lever back to the secure position (see Figure 45, step 3).

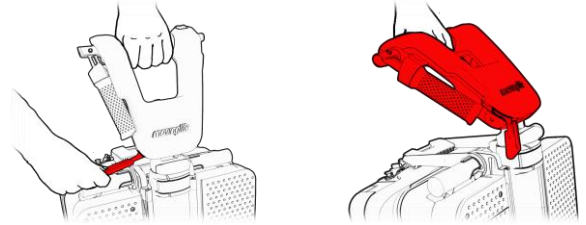

Figure 45

## Trolley Mode

1. Make sure your ATTO is on flat ground before moving to Trolley mode.
2. Press the rod button (see Figure 46, step 1) and tilt it away from the main ATTO body (see Figure 46, step 2).

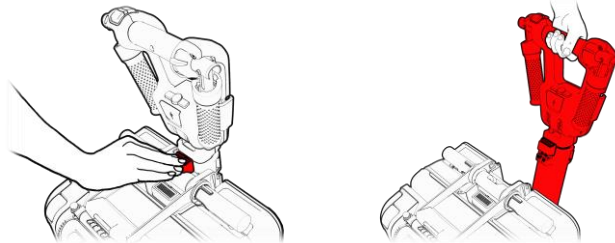

Figure 46

3. Hold ATTO by the handlebar and rotate the main handle by 180 degrees (see Figure 47).

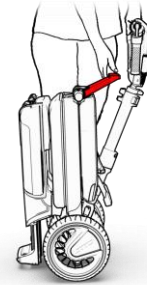

Figure 47

4. Connect the main handle to the rod button housing (See Figure 48).

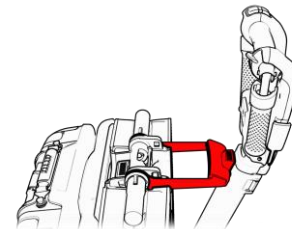

Figure 48

# Separating the Chassis

## ▲ WARNING

Lifting ATTO by yourself may be challenging. If you have another person to assist you, we suggest lifting it together. If you need to lift ATTO alone, you can separate ATTO into two segments as described below. Lifting ATTO as a whole unit may be too heavy for you and may cause injury or damage.

ATTO's front and rear halves (chassis) can be separated and reassembled quickly and easily. This is a very useful feature when storing the ATTO in the trunk of a car or in an airplane's overhead bin.

1. Make sure the handlebar is secured in an upright position (see Figure 49).

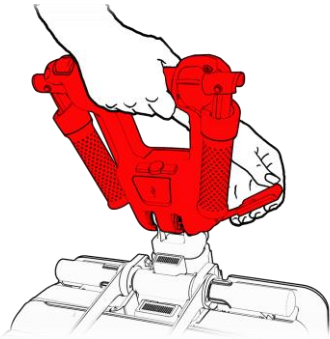

Figure 49

2. Open both separation levers (see Figure 50).

In case the separation levers require a significant amount of force to operate, apply horizontal pressure on the driving console toward the center of the ATTO. This will release pressure on the separation levers and make them easier to open.

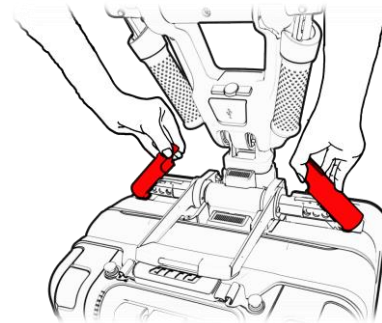

Figure 50

3. Hold the handlebar with one hand and press the central release button with your other hand until you feel a click (see Figure 51).

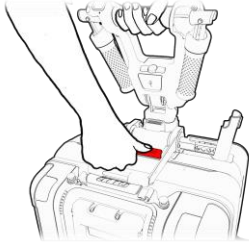

Figure 51

4. Move the front chassis from the handlebar and separate from the back chassis (see Figure 52).

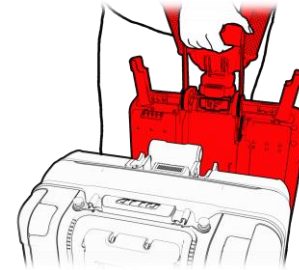
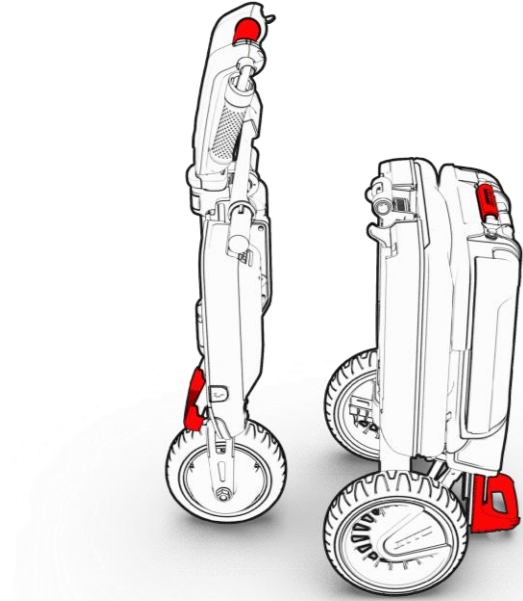

Figure 52

# Lifting Separated Chassis

1. Once the two chassis have been separated and you are ready to lift them, for instance into your car, make sure both chassis are set flat on the ground where they will not be an obstacle to you or others.
2. Grab each of the chassis one at a time using its designated handles and carry it to its destination.  
(See Figure 53).
3. Lay the chassis flat and secure them with straps (or by other methods).



---

Figure 53 Lifting points

---

## Connecting the Chassis

1. Make sure the handlebar is secured in an upright position (see Figure 54).

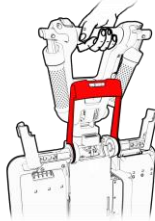

Figure 54

Place the back chassis vertically. Hold the front chassis by the handlebar and bring it toward the back chassis (see Figure 55).

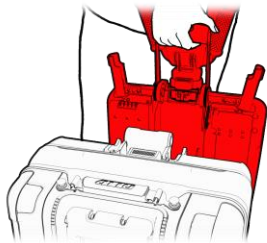

Figure 55

2. Bring the two parts together and use the hanging hooks (see Figure 56) to align the two ends properly. At this point the central release button will click.

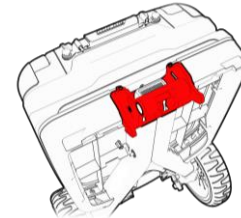
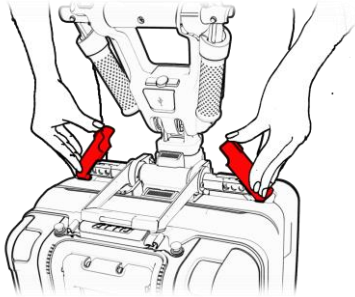

Figure 56

3. Close the two separation levers until they click (see Figure 57). In case the separation levers require a significant amount of force to operate, apply horizontal pressure on the driving console handle toward the center of the ATTO. This will release pressure on the separation levers and will make them easier to close.



---

Figure 57

---

**NOTE**

DO NOT try to open ATTO for driving before the two levers are secured in the downward position.



## Freewheel

ATTO is equipped with a manual freewheel lever, which when pushed to “N” puts ATTO in Freewheel mode and allows it to be pushed.

### ⚠ WARNING

When ATTO is in Freewheel mode, the braking system is disengaged, and ATTO will move freely with very little force. Be careful when operating your ATTO in Freewheel mode to prevent injury or property damage.

- Change to Freewheel mode only on a level surface.
- Ensure ATTO's power is turned off.
- Never sit on ATTO while handling the freewheel lever.

### ⚠ WARNING

When you have finished pushing your ATTO, always lock the brakes by pushing the freewheel lever to “D” mode.

## Operating the Freewheel

In case the battery dies or when ATTO is not in use, it may be rolled manually. This will require releasing the mechanical autobrake of the front wheel by pushing the freewheel lever toward "N" mode (see Figure 58).

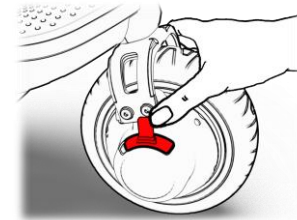

Figure 58 Releasing the freewheel

Before driving your ATTO again, make sure the freewheel lever is pushed backward to "D" mode (see Figure 59).

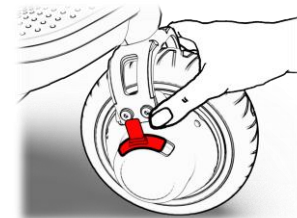

Figure 59 Securing the freewheel

# Battery and Charger

ATTO's charger is small and powerful with the ability to connect to any electrical grid rating 110VAC-240VAC. It is fully approved and safe to use.

- When connecting the charger, connect the DC charging cord to the battery charge plug before connecting the charger AC cord to the electrical outlet.
- When disconnecting the charger, always do so in reverse order of the connecting procedure.



Figure 60 Standard Flight battery (top)  
and XL Flight battery (bottom)



Figure 61 ATTO & ATTO SPORT charger

## XL Flight Battery (ATTO SPORT)

The default battery provided with the ATTO SPORT is composed of 2 units that supply 140.4 Wh each and can therefore be boarded on airplanes. Separate the units by lifting the spring grip and pulling one unit out. The ATTO Mobility Scooter cannot be operated using only one section of the battery.

## Charging the Battery

### NOTE

- a. The battery should not be emptied. To maintain a good battery state and maximize its lifespan, always charge the battery when the battery meter reaches 2 green lines.
- b. When leaving the battery in the ATTO for a long period of time, make sure to charge it to about 60% of a full charge.

1. Connect the charger to the electric socket. The Green LED will turn green to indicate the charger is properly connected to the socket.
2. Connect the other end of the charger to ATTO's battery. The charger LED will turn red to indicate that the battery is not fully charged, and that it is currently charging.
3. When the battery is fully charged, the LED will turn green. This may take 5 to 6 hours. Once charging is completed, disconnect the charger from the wall socket and then disconnect the battery from the charger.

### NOTE

The battery can be charged either when connected to ATTO or when separated from ATTO.

## Maximizing Battery Lifetime

### WARNING

Always keep batteries in cool, dry conditions to prevent damage to the battery and surrounding equipment.

## Remote Key Fob (ATTO SPORT)

ATTO SPORT comes with a pair of remote key fobs that enable remote locking and unlocking of the scooter. The scooter is also turned on using the remote's **Unlock** button.



Figure 62 ATTO SPORT & ATTO SPORT MAX **Unlock** button

To lock the scooter, click the **Lock** button while the scooter is on.



Figure 63 ATTO SPORT & ATTO SPORT MAX **Lock** button

Once the scooter is locked using the remote, it can only be activated using the remote and cannot be turned on using the scooter's onboard **ON/OFF** button.

**Pairing the Remote Key Fob** (\* Required only when a new fob has been provided to replace one of the two originals, or in cases of a replaced scooter controller.)

1. Turn off the scooter.
2. Press the **ON/OFF** button and the “+” button at the same time to enter the menu screen.
3. Switch through the menu screens using the **Power** button and click “+” once you reach the pairing screen.
4. When the “Pair” option flashes on the screen, click any button on the remote until the flashing stops.
5. Restart the scooter.
6. Your new key fob is paired with the scooter and ready for use.

## Rear Light Lifting Handle (ATTO SPORT)

The rear lifting handle comes with a chargeable light that enhances the visibility of the scooter from afar and in the dark. The light has 3 modes: On, Flashing and Off. Press the button on the right side of the handle, to switch between the modes.



## Charging the Rear Light Lifting Handle

The rear light can be charged either via the USB charger onboard the scooter, or via a suitable external USB charger.

To charge onboard the scooter, place the scooter in its folded position (see instructions in this manual), and switch the scooter on. Connect the charging cable provided with the ATTO SPORT to the rear light's charging port, and to the front tiller's charging plug.

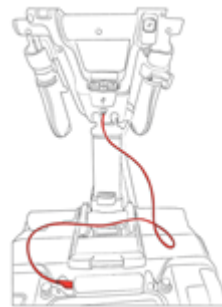

Figure 64 ATTO SPORT/ATTO SPORT MAX Charging the Rear Light Lifting Handle

# Error Codes

When ATTO's smart controller detects a problem, you will be notified by a letter (A-Z) and/or a number (1-9) shown on the driving console display.

Some errors are insignificant and do not affect your ability to use ATTO such as a call for service, while other errors are significant and critical and may require you to stop operating your ATTO.

The following table details error codes and their meanings.

Code	Severity	Explanation and what to do
E1	Low	Blinking 'E1'. Freewheel handle is in Neutral mode. Turn it to Drive mode to turn on ATTO.
E2	Low	Blinking 'E2'. Throttle may be pressed while ATTO is turned on. Release the throttle. If problem persists restart ATTO. Otherwise, contact support.
E3	High	Blinking 'E3'. Motor reports an overload. Shutdown ATTO, wait 10 minutes and restart.
E4	Low	Blinking 'E4'. USB port reports an error. Disconnect any device. Check if port is wet. Restart ATTO.
E5	High	Blinking 'E5'. Internal communication error occurred due to wiring or internal electric problem. Contact support.
E6	Low	Blinking 'E6'. Controller is overheated. Shutdown ATTO, wait 10 minutes and restart.
E7	Low	Blinking 'E7'. Controller sensed under-voltage. Stop ATTO and restart.
E8	High	Blinking 'E8'. Motor Sensors malfunction. Contact support.
Fd	None	Blinking 'Fd'. Not an error code. Indicates the state of software updating.

# TRANSPORTING ATTO

ATTO can be effortlessly transported in many types of vehicles, on land, sea or by air.

Transporting ATTO on commercial aircraft is subject to federal regulations and airline policy. Please consult your airline prior to departure to ensure that your ATTO and its lithium-ion battery will be permitted onboard.

To transport ATTO:

- For safety reasons, remove the battery and place it in a safe location.
- Make sure the ATTO is locked in position.
- To prevent injury and damage, secure the ATTO in a way that will prevent it from moving around or shaking.
- Cover or otherwise secure the tiller and handlebar to prevent it from being damaged due to moving objects or by your ATTO shifting around during transport.

To transport ATTO in a car, please see the Separating the Chassis section in this Owner's Manual.

- If the ATTO and its components are not properly and securely stowed, the ATTO or its components may shift around while driving causing injury or damage.
- If the ATTO is transported in a vehicle when fully assembled and in open position, no one should sit on the ATTO during loading and transport.
- If you use an external lifting system, be sure to secure your ATTO as it could fall off the lift.

When transporting ATTO, make sure it is always in an environment within the allowed specifications for humidity and temperature.

# TROUBLESHOOTING

## If Your ATTO Does Not Operate

1. If ATTO is turned on and then immediately shuts itself down, please check to ensure the freewheel lever is in Drive mode.
2. Ensure the charger is not connected to ATTO.
3. Check the battery to see if it is charged. If you are not sure, connect it to the charger and wait for the green LED.
4. Once you are sure the battery is not empty: Ensure the battery is properly placed in the battery housing on the ATTO and that there is no foreign material such as paper or dirt interfering with the electrical contact between the battery and its connector.
5. If the problem still exists, check the fuse. If it is blown, replace it according to the procedure in the Maintenance section of this Owner's Manual.
6. Once you make sure the fuse is working, try to turn the ATTO on by pressing the ON/OFF button for at least two seconds. If ATTO still does not turn on, please contact an authorized Movinglife dealer.

## ATTO Is ON But Does Not Move

Start by checking the freewheel lever; make sure it is in a locked position as described in the Operation section of this Owner's Manual.

## Charging Problems

If batteries fail to charge within 12 hours:

- Check the battery connector.
- It may be necessary to have the batteries or charger checked and replaced. Contact an authorized Movinglife dealer.

### **NOTE**

ATTO's battery can be charged both while it is installed on the ATTO and when it has been removed from the ATTO.

### **WARNING**

Do not leave the battery pack and charger plugged in for more than 12 hours. This could damage the battery pack or create a hazardous condition.



# MAINTENANCE

ATTO's expected service life is 10 years and it will extend much longer provided care and maintenance procedures are carefully followed. Please follow the maintenance procedures whenever needed or at least once a year. Replacement parts are available from Movinglife and authorized service facilities. (See the back cover for details.)

## Electrical Fuse

Your ATTO Battery has a protecting fuse at the bottom of the battery pack (see Figure 65).

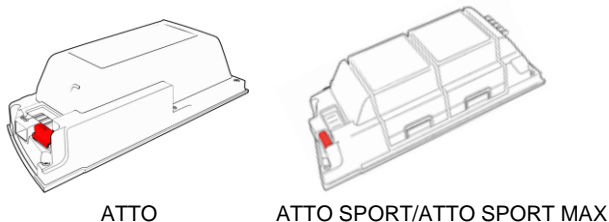

Figure 65 Fuse location

## Possible Causes of a Blown Fuse

The fuse is designed to protect the battery from overcharging/discharging. You should check the condition of the fuse if:

- The battery is not charging.
- A charged battery is connected to ATTO but ATTO does not turn on.
- ATTO has turned off unexpectedly during operation.

## Replacing a Blown Fuse

To check the fuse (see Figure 66):

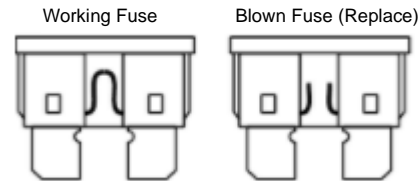

Figure 66 Identifying fuse condition

- Remove the battery and place it on a secure surface such as a table, with its bottom facing up.
- Remove the fuse plastic cover.
- Pull out the fuse.

Examine the fuse to see if it is blown. A blown fuse has a gap in the wire. If it is blown (see Figure 63), replace it with a new fuse blade type ATO or ATC, Green (30A).

Insert the new fuse and replace the plastic cover (Figure 67).

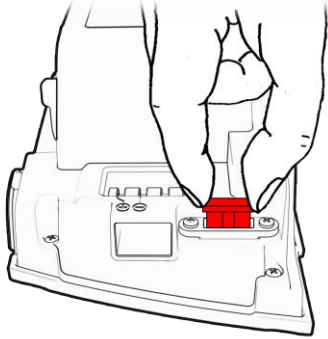

Figure 67 Replacing a blown fuse

**▲ WARNING**

Never immerse or hose down your ATTO in any liquid. This may cause personal injury and/or damage to your ATTO.

**ⓘ NOTE**

If the fuse continues to blow, an underlying electrical fault needs professional attention. Please contact an authorized Movinglife dealer.

**ⓘ NOTE**

Do not replace the fuse repeatedly. If you suspect there is an underlying problem, contact an authorized dealer. Failure to correct the problem could cause injury or damage and will void the warranty.

**REQUIRES TOOLS**

Do not attempt electrical repairs. Consult Movinglife or your authorized Movinglife dealer.

## Wheels and Tires

Your ATTO is equipped with one front motor with a solid tire and two rear wheels with solid tires. The tires are filled with a special foam, not air. You will never have a flat or punctured tire. If there is a need to replace a tire due to erosion or damage, please contact an authorized Movinglife dealer.

## Lubrication

There are two areas where a light spray of lubricant should be applied every six months, or more frequently if opening and closing ATTO becomes more difficult to perform (you may use any light lubricant that is not sticky or corrosive on aluminum and plastic).

Lubrication points are shown in Figure 68:

1. Seat post including tracks.
2. Wheel shafts.

Clean the areas to be lubricated with a clean cloth fiber-less cloth, being careful to avoid leaving sand or dust before lubricating the areas. Afterward, test the ATTO for proper and easy operation, then clean the surrounding parts of lubricant residue.

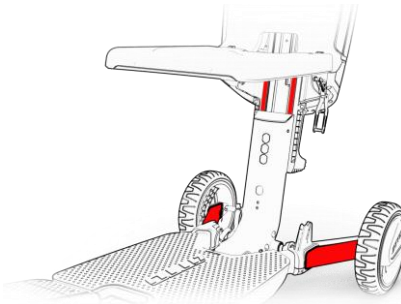

Figure 68

All the bearings on your ATTO are permanently lubricated and sealed and therefore no lubrication is required.

# Battery

## ⚠ WARNING

ATTO's battery holds a substantial amount of power. Shorting of the terminals can result in burns or other injuries as well as damage to the battery and to the electronic components of your ATTO. Always use care and caution when handling the battery.

## Battery and Charging

- Movinglife batteries are maintenance-free.
- Your ATTO is equipped with a Lithium-Ion battery. It is not necessary to completely discharge the battery before recharging it.
- If you are not going to use your ATTO for an extended period of time, charge the batteries to 60% of the full charge before storing your ATTO. The batteries can be left unmaintained for up to 6 months if they are properly charged and kept at room temperature – approximately 22°C (~ 72°F).
- If you have not used your ATTO for more than one month, make sure that you charge the battery the night before you are going to use it.

This will ensure your ATTO has a fully charged battery.

- There is no danger of spillage or leakage, so these batteries are safe to transport on aircrafts, busses, trains, etc.
- Following the procedures set out in this Owner's Manual will help extend the life of your batteries.
- If electrical terminals on the ATTO become corroded, they need to be cleaned by a certified Movinglife technician.
- If the battery terminals become corroded, replace the battery.

## ⚠ WARNING

FIRE HAZARD! Do not cover the battery charger and ventilation slot while charging your battery. Only use the battery charger in well-ventilated areas.

## Cleaning and Body Care

ATTO's body is made of ABS parts, a durable plastic with integrated paint. To help ATTO retain a high gloss, clean it using a clean damp cloth (moistened with water).

## Maintaining the Front Handle Brake (ATTO SPORT)

Once a month, check that the manual brake lever brings the scooter to a stop when squeezed. If it does not, contact an authorized Movinglife dealer.

### Storage

If you plan to store your ATTO for an extended period of time, it is best to:

- Remove the battery pack from the ATTO.
- Store your ATTO in a dry environment.
- Avoid storing your ATTO where it will be exposed to temperature extremes.
- Remove the battery fuse.

#### **▲ WARNING**

Always protect batteries from freezing temperatures and never charge a frozen battery. This damages the battery and can cause personal injury.

To use your ATTO after an extended period of storage:

- Open the scooter if it was closed/folded during storage.
- Visually inspect all user adjustment levers, look for possible damage in plastic and metal parts, and ensure all moving parts work and show no evidence of corrosion. If you do find a part which does not function as expected or has corrosion, call a certified technician for advice on how to proceed.
- Insert the battery and turn the ATTO on.
- Check that the display and all buttons work as expected. If you find no problems you may use your scooter, otherwise call an authorized Movinglife technician for advice.

## Disposal

Your ATTO must be disposed of according to applicable local and national statutory regulations. Contact your local waste disposal agency or authorized Movinglife dealer for information on proper disposal of packaging, metal frame components, plastic components, electronics, and battery.

## Spare Parts

Spare parts can be purchased directly from a local representative.

## Accessories

ATTO Accessories are a range of versatile, innovative products created specifically to support and work with ATTO Mobility Scooters. Many can be installed once and then used in all user modes; while driving, wheeling along as a trolley and when folded for storage. All accessories are designed to provide user comfort, convenience, and safety. You can mix and match the accessories to assemble the perfect ATTO to fit you, your needs, and your lifestyle! These products can be purchased directly from Movinglife or from a local dealer or representative.

# SPECIFICATIONS

## Model – ATTO Mobility Scooter

### Speed

ATTO maximum speed (limited by software) is 6.4 km/h (4 mph). Maximum driving speed can be set to one of the presets by simply clicking a button and watching the indication on ATTO's clear view display.

### Weight

Part	Kg	Lbs
Front half	12	26.4
Rear half	17	37.5
Assembled *	29	63.9
Battery	1.85	4.1

\* Without the battery

### Weight Capacity

Maximum user weight is 120 kg (265 lbs).

### Dimensions

When folded, ATTO is the most compact mobility scooter in the world. Nevertheless, when open and ready to drive, ATTO is the largest and most comfortable in its category.

ATTO dimensions, units in cm (inch):

Part	Height	Length	Width
Trolley mode	72 (28)	39 (15.3)	42 (16.5)
Drive mode	90 (35)	120 (47)	56 (22)

### Ground Clearance

ATTO's ground clearance is 10 cm (4").

### Front Wheel Drive Motor

To provide a smooth and continuous ride over many years and great distance, we developed a unique, fully customized, brushless, permanent magnet DC motor, combining a solid core and a powerful gear along with a robust braking mechanism. Via sophisticated software algorithms, the motor utilizes modern reverse charging techniques for deceleration and stopping, while providing a smooth driving experience.

## Tires

PU filled non-pneumatic tires.

## Battery

ATTO uses a powerful, yet compact, advanced lightweight 48 Volts Lithium-Ion battery. Weighing only 2 kg (4.4 lbs), the battery allows for more than 20 km (12.5 miles) of continuous driving while requiring only 4 hours (on average) to fully charge. You can charge ATTO onboard and offboard, for your convenience. Removing the battery is as easy as is putting it back in place.

## Operating Range

Battery model	Metric	Imperial
249.6 Wh	20 km	12.5 mile

## Charger

UL and CE approved, the charger has self-shutdown functionality for safety and extended battery and charger life.

## Controller

The unique Brushless DC Motor Controller by Movinglife Ltd has a unique LED display with dimming option and a clear error view. Internal data and an error log make for easy maintenance and

traceability. The Movinglife Controller provides 10A continuous working current with a maximum of 30A peak.

## Turning Radius

1.35 meters (53").

## Freewheel Mode

Yes.

## Maximum Incline

6 degrees.

## Height Restrictions

Preliminary tests show that a minimum height of 150 cm (5 feet) is required for safe driving. This is NOT a formal recommendation. For any questions, check with your medical provider.

## Environment

### NOTE

Owners and operators should always adhere to the following precautions:

- Refrain from modifying the ATTO Mobility Scooter hardware or software in any way.
- Never allow untrained personnel to operate the ATTO Mobility Scooter.



- Always report to Movinglife Ltd. authorized representatives only.

ATTO was designed and tested according to strict water resistance IP54 standards, requiring the equipment to be water resistant to splash from multiple angles, for an extended period of time and at high pressure. ATTO withstood the testing and continued to work with zero malfunctions, which guarantees resistance to normal outdoor conditions. Nevertheless, we recommend operating your scooter only in dry weather conditions and storing your ATTO indoors to ensure performance and safety.

## Flammability

ATTO is designed according to UL94 V-0.

## Manufacturer Responsibility

The manufacturer considers itself responsible for the effects on safety, reliability, and performance of the equipment only if:

- Calibration, service, and repairs of the ATTO Mobility Scooter are carried out by Movinglife Ltd. personnel or anyone authorized by Movinglife Ltd.
- The equipment is used in full accordance with the user instructions.

# Model – ATTO SPORT Mobility Scooter

## Speed

ATTO SPORT maximum speed (limited by software) is 10 km/h (6.2 mph). Maximum driving speed can be set to one of the presets by simply clicking a button and watching the indication on ATTO's clear view display.

## Weight

Part	Kg	Lbs
Front half	12.5	27.5
Rear half	17.5	38.6
Assembled *	30	66.1
Battery	2.1	4.6

## Weight Capacity

Maximum user weight is 120 kg (265 lbs).

## Dimensions

When folded, ATTO SPORT is the most compact mobility scooter in the world. Nevertheless, when open and ready to drive, ATTO SPORT is the largest and most comfortable in its category.

ATTO SPORT's dimensions, units in cm (inch):

Part	Height	Length	Width
Trolley mode	72 (28)	39 (15.3)	44.5 (17.5)
Drive mode	90 (35)	120 (47)	58.2 (23)

## Ground Clearance

ATTO SPORT 's ground clearance is 10 cm (4”).

## Front Wheel Drive Motor

To provide a smooth and continuous ride over many years and great distance, we developed a unique, fully customized, brushless, permanent magnet DC motor, combining a solid core and a powerful gear along with a robust braking mechanism. Via sophisticated software algorithms, the motor utilizes modern reverse charging techniques for deceleration and stopping, while providing a smooth driving experience.

## Tires

Shock-absorbing airless NPT tires.

## Battery

ATTO SPORT uses a powerful, yet compact, advanced lightweight 48 Volts Lithium-Ion battery. Weighing only 2.1 kg (4.6 lbs), the battery allows for more than 30 km (18.6 miles) of continuous driving while requiring only 4 hours (on average), to fully charge. You can charge ATTO SPORT

onboard and offboard, for your convenience. Removing the battery is as easy as is putting it back in place. The battery can be split into 2 sections of 140.4 W/h cells. This enables users to board airplanes with the scooter.

### Operating Range

Battery model	Metric	Imperial
280.8 Wh	30 km	18.6 mile

### Charger

UL and CE approved, the charger has self-shutdown functionality for safety and extended battery and charger life.

### Controller

The unique Brushless DC Motor Controller by Movinglife Ltd has a unique LED display with dimming option and a clear error view. Internal data and an error log make for easy maintenance and traceability. The Movinglife Controller provides 10A continuous working current with a maximum of 50A peak.

### Turning Radius

1.35 meters (53”).

### Freewheel Mode

Yes.

### Maximum Incline

6 degrees.

### Height Restrictions

Preliminary tests show that a minimum height of 150 cm (5 feet) is required for safe driving. This is NOT a formal recommendation. For any questions, check with your medical provider.

### Environment

Owners and operators should always adhere to the following precautions:

- Refrain from modifying the ATTO SPORT Mobility Scooter hardware or software in any way.
- Never allow untrained personnel to operate the ATTO SPORT Mobility Scooter.
- Always report to Movinglife Ltd. authorized representatives only.

ATTO SPORT was designed and tested according to strict water resistance IP54 standards, requiring the equipment to be water resistant to splash from multiple angles, for an extended period of time and at high pressure. ATTO SPORT withstood the testing and continued to work with zero malfunctions, which guarantees resistance to normal outdoor conditions. Nevertheless, we recommend operating your scooter only in dry weather conditions and storing your ATTO SPORT indoors to ensure performance and safety.

## **Flammability**

ATTO SPORT is designed according to UL94 V-0.

## **Manufacturer Responsibility**

The manufacturer considers itself responsible for the effects on safety, reliability, and performance of the equipment only if:

- Calibration, service, and repairs of the ATTO SPORT Mobility Scooter are carried out by Movinglife Ltd. personnel or anyone authorized by Movinglife Ltd.
- The equipment is used in full accordance with the user instructions.

## Model – ATTO SPORT MAX Mobility Scooter

### Speed

ATTO SPORT MAX's maximum speed (limited by software) is 8 km/h (5 mph). Maximum driving speed can be set to one of the presets by simply clicking a button and watching the indication on ATTO's clear view display.

### Weight

Part	Kg	Lbs
Front half	12.5	27.5
Rear half	17.5	38.6
Assembled *	30	66.1
Battery	2.1	4.1

### Weight Capacity

Maximum user weight is 136 kg (300 lbs).

### Dimensions

When folded, ATTO SPORT MAX is the most compact mobility scooter in the world.

Nevertheless, when open and ready to drive, ATTO

SPORT MAX is the largest and most comfortable in its category.

ATTO SPORT MAX's dimensions, units in cm (inch):

Part	Height	Length	Width
Trolley mode	72 (28)	39 (15.3)	44 (17.5)
Drive mode	90 (35)	120 (47)	58.5 (23)

### Ground Clearance

ATTO's ground clearance is 10 cm (4").

### Front Wheel Drive Motor

To provide a smooth and continuous ride over many years and great distance, we developed a unique, fully customized, brushless, permanent magnet DC motor, combining a solid core and a powerful gear along with a robust braking mechanism. Via sophisticated software algorithms, the motor utilizes modern reverse charging techniques for deceleration and stopping, while providing a smooth driving experience.

## Tires

Shock-absorbing airless NPT tires.

## Battery

ATTO SPORT MAX uses a powerful, yet compact, lightweight advanced 48 Volts Lithium-Ion battery. Weighing only 2.1 kg (4.6 lbs). The battery allows for more than 27 km (16.7 miles) of continuous driving while requiring only 4 hours (on average), to fully charge. You can charge ATTO SPORT MAX onboard or offboard, meaning that you can (but do not have to), take the battery off the ATTO SPORT MAX in order to charge it. Removing the battery is as easy as pressing a button. Reinstalling the battery is as easy as putting it back in place. The battery can be split into 2 sections of 140.4 W/h cells. This enables users to board airplanes with the scooter.

## Operating Range

Battery model	Metric	Imperial
280.8 Wh	27 km	16.7 mile

## Charger

UL and CE approved, the charger has self-shutdown functionality for safety and extended battery and charger life.

## Controller

Unique Brushless DC Motor Controller is a genuine product by Movinglife Ltd. With a unique LED Display with dimming option and a clear error display, the controller has an Internal data and error log for easy maintenance and traceability. The Movinglife Controller provides 10A continuous working current with a maximum of 50A peak.

## Turning Radius

1.35 meters (53”).

## Freewheel Mode

Yes.

## Maximum Incline

6 degrees.

## Height Restrictions

Preliminary tests show that a minimum height of 150 cm (5 feet) is required for safe driving. This is NOT a formal recommendation. For any questions, check with your medical provider.

## Environment

Owners and operators should always adhere to the following precautions:

- Refrain from modifying ATTO SPORT MAX Mobility Scooter hardware or software in any way.
- Never allow untrained personnel to operate the ATTO SPORT MAX Mobility Scooter.
- Always report to Movinglife Ltd. authorized representatives only.

ATTO SPORT MAX was designed and tested according to strict water resistance IP54 standards, requiring the equipment to be water resistant to splash from multiple angles, for an extended period of time and at high pressure. ATTO SPORT MAX withstood the testing and continued to work with zero malfunctions, which guarantees resistance to normal outdoor conditions. Nevertheless, we recommend operating your scooter only in dry weather conditions and storing your ATTO SPORT MAX indoors to ensure performance and safety.

## Flammability

ATTO SPORT MAX is designed according to UL94 V-0.

## Manufacturer Responsibility

The manufacturer considers itself responsible for the effects on safety, reliability, and performance of the equipment only if:

- Calibration, service, and repairs of the ATTO SPORT MAX Mobility Scooter are carried out by Movinglife Ltd. personnel or anyone authorized by Movinglife Ltd.
- The equipment is used in full accordance with the user instructions.

# CONTACT INFORMATION

## **Legal Manufacturer**

Movinglife Ltd.

Netzer Sereni 7039500 Israel

Tel: +972(73)391-3999

Email: [info@movinglife.com](mailto:info@movinglife.com)



## **Authorized representative**

Obelis Group Ltd.

Bd Général Wahis, 53,

B-1030 Brussels

Belgium

## **US IMPORTER:**

Movinglife Inc.

Tour Scotia, 1002 rue Sherbrooke O.

Bureau 1900, Montreal, Quebec, H3A 3L6 Canada

Tel +1(347)761-3317



# NOTES

ATTO | ATTO SPORT | ATTO  
SPORT MAX Owner's Manual  
English  
Ver 4.0  
5<sup>th</sup> Issue - March 2021



Copyright © 2020-  
2021  
All rights reserved